

VIRINETA 30 METŲ
1995-2025

DIDMENINĖ IR MAŽMENINĖ PREKYBA VANDENTIEKIO IR ŠILDYMO ĮRANGA



PREKIŲ KATALOGAS

2026



Interneto svetainė: www.virineta.lt

Turinys

VANDENS SIURBLIAI

<i>PEDROLLO automatinės vandens tiekimo sistemos</i>	3
<i>HALM, ARMSTRONG, CEVA, IBO cirkuliaciniai siurbliai</i>	4
<i>PEDROLLO vandens siurbliai</i>	6
<i>Horizontalūs daugiapakopiai siurbliai</i>	9
<i>PEDROLLO vertikalūs siurbliai</i>	10
<i>PEDROLLO baseinų siurbliai</i>	12
<i>PEDROLLO nerūdyjančio plieno siurbliai</i>	13
<i>PEDROLLO konsoliniai vandens siurbliai</i>	14
<i>PEDROLLO giluminiai siurbliai šuliniams</i>	17
<i>4" PEDROLLO giluminiai siurbliai</i>	18
<i>4" SISTEMA giluminiai siurbliai</i>	21
<i>4" Siurblių komplektai su varikliais 4OME-150</i>	22
<i>4" PEDROLLO siurblių hidraulinės dalys</i>	23
<i>6" PEDROLLO giluminiai siurbliai</i>	26
<i>6" PEDROLLO siurblių hidraulinės dalys</i>	28
<i>3" PEDROLLO, IBO, CEVA giluminiai siurbliai</i>	30
<i>Varikliai giluminiams siurbliams</i>	31
<i>PEDROLLO drenažiniai siurbliai</i>	33
<i>PEDROLLO nuotėkų siurbliai</i>	34
<i>PEDROLLO nuotėkų mini siurblinės</i>	38
<i>CEVA siurbliai</i>	39
<i>IBO siurbliai</i>	41
<i>Paleidimo ir apsaugos pultai</i>	43
<i>Dažnio keitikliai</i>	44
<i>Siurblių priedai ir atsarginės dalys</i>	47
<i>VAREM, AQUASKY, GWS hidroforai</i>	49

VANDENS ŠILDYTUVAI

<i>ATLANTIC vandens šildytuvai</i>	50
<i>ARISTON vandens šildytuvai</i>	55
<i>GORENJE TIKI vandens šildytuvai</i>	58
<i>KOSPEL vandens šildytuvai</i>	59
<i>KOSPEL momentiniai vandens šildytuvai</i>	62
<i>Atsarginės dalys vandens šildytuvams</i>	63

ŠILDYMO ĮRANGA



<i>CEVA, ATLANTIC elektriniai konvektoriai</i>	69
<i>ATLANTIC rankšluoščių džiovintuvai</i>	71
<i>WENDENG EVERGREEN ketinės krosnelės</i>	73
<i>KOSPEL elektriniai katilai</i>	74
<i>VAREM išsiplėtimo indai</i>	77

JUNGTYS, VENTILIAI, VAMZDŽIAI, ŽARNOS

<i>Žalvarinės PE vamzdžių jungtys</i>	78
<i>Plastikinės PE vamzdžių jungtys</i>	79
<i>Žalvariniai srieginiai sujungimai</i>	80
<i>Rutuliniai ventiliai, atbuliniai vožtuvai, purvarinkiai</i>	81
<i>ESPIROFLEX PVC techninės žarnos</i>	82

Automatinės vandens tiekimo sistemos PEDROLLO



Pavadinimas	Hidroforo talpa, l	Įsiurbimo gylis, m	Galingumas, kW	Slėgis, m	Našumas, m ³ /val	Kaina, Eur su PVM	
PKm60-24 CL	20	7	0,30	5-38	2,4-0,3	190,00	
FUTURE JETm1BX-24 CL	20	9	0,48	5-36	6,7-0,3	242,00	
FUTURE JETm1AX-24 CL	20	9	0,55	9-44	6,0-0,3	255,00	
FUTURE JETm1A-ST-24 CL	20	9	0,55	9-44	6,0-0,3	310,00	
FUTURE JETm2CX-24 CL	20	9	0,75	10-52	7,2-0,3	292,00	
FUTURE JETm2AX-24 CL	20	9	0,9	13,7-56	7,2-0,3	342,00	
FUTURE JETm2CX-50 CL	50	9	0,75	10-52	7,2-0,3	399,00	
FUTURE JETm2AX-60CL	60	9	0,9	13,7-56	7,2-0,3	440,00	
FUTURE JETm1AX-100 CL	100	9	0,55	9-44	6,0-0,3	495,00	
FUTURE JETm1BX-24 APT	20	9	0,48	5-36	6,7-0,3	295,00	
FUTURE JETm1AX-24 APT	20	9	0,55	9-44	6,0-0,3	310,00	
PLURIJETm4/80-24 APT	24	9	0,55	10-50	4,8-0,3	415,00	
FUTURE JETm2CX-24APT	24	9	0,75	10-52	7,2-0,3	349,00	
FUTURE JETm2AX-24 APT	24	9	0,9	13,7-56	7,2-0,3	397,00	
FUTURE JETm2CX-40 APT	40	9	0,75	10-52	7,2-0,3	397,00	
FUTURE JETm2CX-60APT	60	9	0,75	10-52	7,2-0,3	427,00	
FUTURE JETm2AX-60APT	60	9	0,9	13,7-56	7,2-0,3	476,00	
PLURIJETm4/80-60 APT	60	9	0,55	10-50	4,8-0,3	475,00	
FUTURE JETm2CX-80 APT	80	9	0,75	10-52	7,2-0,3	463,00	
FUTURE JETm2AX-80 APT	80	9	0,9	13,7-56	7,2-0,3	515,00	
JDWm1AX/30-24 CL	20	20	0,75	18-42	1,0-0,12	385,00	
JDWm2A/30-24 CL	20	30	1,1	30	0,96	515,00	
JDWm2A/30-60 CL	60	30	1,1	30	0,96	589,00	

GARANTIJA SIURBLIAMS – 24 MĖNESIAI, HIDROFORAMS APT – 60 MĖNESIŲ

Automatinės vandens tiekimo sistemos su dažnio keitikliu DG BLU

Pavadinimas	Hidroforo talpa, l	Įsiurbimo gylis, m	Galingumas, kW	Slėgis, m	Našumas, m ³ /val	Kaina, Eur su PVM	
DG-BLU 2	-	8	0,55	10-45	4,5-0,3	899,00	
DG-BLU 3	-	8	0,75	10-50	6,6-0,3	949,00	
DG-BLU 5	-	8	1,1	10-60	7,8-0,3	999,00	
DG -BLU 2, 3, 5 su bluetooth pajungimu papildomai						40,00	
DUAL-DG-BLU 3+3	-	8	0,75+0,75	10-50	13,2-0,3	2730,00	
DUAL-DG-BLU 3+5	-	8	0,75+1,1	10-50	14,4-0,3	2772,00	
DUAL-DG-BLU 5+5	-	8	1,1+1,1	10-60	15,6-0,3	2860,00	

Kodas	Pavadinimas	Kaina, Eur su PVM
ASSKITDGP01	Dviejų DG-BLU siurbių pajungimo komplektas	460,00
ASSKITDGP02	Sienos montavimo komplektas vienam DG-BLU siurbliui	74,00
ASSKITDGP03	Sienos montavimo komplektas dviem DG-BLU siurbliams	97,00
ASSKITDGP04	Elektroninė išplėtimo plokštė	107,00



Cirkuliaciniai siurbLIAI

Cirkuliaciniai siurbLIAI karštam geriamajam vandeniui BUPA (Vokietija) ARMSTRONG

Markė	Pajungimo diametrai	Galia, W	H, m	Q, m ³ /val	Kaina, EUR su PVM
AFT BUPA 25-4.0 G180	1½"	33 – 44	0 – 4,0	2,8 – 0	80,00



3-ių greičių reguliatorius, nuorintojo varžtas, ketinis siurblio korpusas padengtas kataforetinu sluoksniu, kompaktiškas dizainas, darbinė temperatūra nuo +2°C iki +110°C, triukšmo lygis ≤45 dB (A). **GARANTIJA – 24 MĖNESIAI**

A klasės cirkuliaciniai siurbLIAI šildymo sistemoms HEP PLUS (Vokietija)



Markė	Pajungimo diametrai	Galia, W	H, m	Q, m ³ /val	EEI	Kaina, EUR su PVM
HEP Plus 25-4 E180	1½"	4 – 23	0 – 4,0	2,5 – 0	≤0,20	142,00



Elektroninis valdymas, LED ekranas, kompaktiškas dizainas, sklaidi eiga, labai mažos energijos sąnaudos, integruota naktinio režimo funkcija, nuorintojo varžtas, patogus valdymas, sumontuotas išardomas pajungimo kištukas, automatinis prisitaikymas prie slėgio sąlygų, specialiais dažais padengtas siurblio korpusas, triukšmo lygis ≤45 dB (A). **GARANTIJA – 24 MĖNESIAI**

A klasės cirkuliaciniai siurbLIAI šildymo sistemoms HEP Optimo (Vokietija)



Markė	Pajungimo diametrai	Galia, W	H, m	Q, m ³ /val	EEI	Kaina, EUR su PVM
HEP Optimo 25-4 G180	1½"	4 – 23	0 – 4,0	2,7 – 0	≤0,20	142,00
HEP Optimo 25-6 G180	1½"	4 – 50	0 – 6,0	3,6 – 0	≤0,23	157,00



Elektroninis valdymas, LED ekranas, nuorintojo varžtas, kompaktiškas dizainas, sklaidi eiga, labai mažos energijos sąnaudos, sumontuotas išardomas pajungimo kištukas, galima nustatyti 3-is skirtingus valdymo režimus: proporcinis slėgis, fiksuotas greitis arba pastovus slėgis, ketinis siurblio korpusas padengtas kataforetinu sluoksniu, darbinė temperatūra nuo +2°C iki +110°C, triukšmo lygis ≤45 dB (A). **GARANTIJA – 24 MĖNESIAI**

Cirkuliaciniai siurbLIAI karštam geriamajam vandeniui CEVA (K.L.R.)



Markė	Pajungimo diametrai	Galia, W	H, m	Q, m ³ /val	Kaina, EUR su PVM
SXR 25/40-180	1½"	38 – 52 – 72	2,0 – 3,0 – 4,0	2,7 – 2,3 – 1,2	31,00
SXR 25/60-180	1½"	48 – 67 – 93	3,0 – 5,0 – 6,0	1,5 – 2,4 – 3,0	33,00
SXR 25/80-180	1½"	135 – 180 – 245	5,0 – 7,0 – 8,0	1,5 – 2,4 – 3,0	62,00



3-ių greičių reguliatorius, nuorintojo varžtas, ketinis siurblio korpusas padengtas kataforetinu sluoksniu, kompaktiškas dizainas, darbinė temperatūra nuo +2°C iki +110°C, triukšmo lygis ≤45 dB (A). **GARANTIJA – 24 MĖNESIAI**

A klasės cirkuliaciniai siurbLIAI šildymo sistemoms CEVA (K.L.R.)



Markė	Pajungimo diametrai	Galia, W	H, m	Q, m ³ /val	EEI	Kaina, EUR su PVM
SXR 25/4A-180	1½"	5 – 22	0 – 4,0	2,4 – 0	≤0,23	87,00
SXR 25/6A-180	1½"	5 – 55	0 – 6,0	3,3 – 0	≤0,23	89,00



Elektroninis valdymas, LED ekranas, nuorintojo varžtas, kompaktiškas dizainas, sklaidi eiga, labai mažos energijos sąnaudos, sumontuotas išardomas pajungimo kištukas, galima nustatyti 3-is skirtingus valdymo režimus: proporcinis slėgis, fiksuotas greitis arba pastovus slėgis, ketinis siurblio korpusas padengtas kataforetinu sluoksniu, darbinė temperatūra nuo +2°C iki +110°C, triukšmo lygis ≤43 dB (A). **GARANTIJA – 24 MĖNESIAI**

A klasės cirkuliaciniai siurbiai šildymo sistemoms IBO BETA2 (Lenkija)



Markė	Pajungimo diametrai	Galia, W	H, m	Q, m ³ /val	EEI	Kaina, EUR su PVM
BETA2 25-60/130	1½"	4 – 22	0 – 6,0	2,88 – 0	≤0,23	98,00
BETA2 25-40/180	1½"	4 – 22	0 – 4,0	2,88 – 0	≤0,23	98,00
BETA2 25-60/180	1½"	4 – 22	0 – 6,0	2,88 – 0	≤0,23	98,00



Elektroninis valdymas, LED ekranas, nuorintojo varžtas, kompaktiškas dizainas, sklandi eiga, labai mažos energijos sąnaudos, sumontuotas išardomas pajungimo kištukas, galima nustatyti 3-is skirtingus valdymo režimus: proporcinis slėgis, fiksuotas greitis arba pastovus slėgis, ketinis siurblio korpusas padengtas kataforetiniu sluoksniu, darbinė temperatūra nuo +2°C iki +110°C, triukšmo lygis ≤43 dB (A). **GARANTIJA – 24 MĖNESIAI**

A klasės cirkuliaciniai siurbiai šildymo sistemoms IBO MAGI2 (Lenkija)



Markė	Pajungimo diametrai	Galia, W	H, m	Q, m ³ /val	EEI	Kaina, EUR su PVM
MAGI2 25-60/130	1½"	5 – 45	0 – 6,0	3,30 – 0	≤0,23	154,00
MAGI2 25-40/180	1½"	5 – 22	0 – 4,0	3,00 – 0	≤0,23	154,00
MAGI2 25-60/180	1½"	5 – 45	0 – 6,0	3,30 – 0	≤0,23	154,00



Elektroninis valdymas, LED ekranas, nuorintojo varžtas, kompaktiškas dizainas, sklandi eiga, labai mažos energijos sąnaudos, sumontuotas išardomas pajungimo kištukas, galima nustatyti 3-is skirtingus valdymo režimus: proporcinis slėgis, fiksuotas greitis arba pastovus slėgis, ketinis siurblio korpusas padengtas kataforetiniu sluoksniu, darbinė temperatūra nuo +2°C iki +110°C, triukšmo lygis ≤43 dB (A). **GARANTIJA – 24 MĖNESIAI**

A klasės cirkuliaciniai siurbiai šildymo sistemoms PEDROLLO DHL EEI≤0,2

Markė	Pajungimo diametrai	Galia, W	H, m	Q, m ³ /val	Kaina, EUR su PVM
DHL 25-60/130	1½"	3 – 42	0,5 – 6,0	3,5 – 0,01	208,00
DHL 25-60/180	1½"	3 – 42	0,5 – 6,0	3,5 – 0,01	212,00



Elektroninis valdymas, darbinė temperatūra nuo +2°C iki +95°C, kompaktiškas dizainas, sklandi eiga, labai mažos energijos sąnaudos, galima nustatyti 3-is skirtingus valdymo režimus: proporcinis slėgis, fiksuotas greitis arba pastovus slėgis, specialiais dažais padengtas siurblio korpusas, triukšmo lygis ≤43 dB (A). **GARANTIJA – 24 MĖNESIAI**

CHARACTERISTIC CURVES ΔP

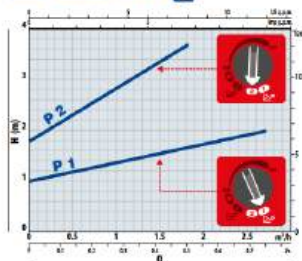

CHARACTERISTIC CURVES ΔC

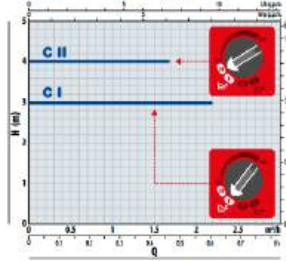

CHARACTERISTIC CURVES MIN-MAX

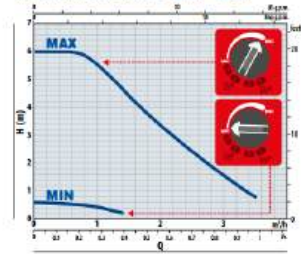



Vandens siurbliai PEDROLLO



Markė 230 V	Markė 400V	Galia, kW	Slėgis, m	Našumas l/min	Pajungi mas	Kaina 230V	Kaina 400V	
<i>PKM 60</i>	<i>PK 60</i>	0,30	38-5	5-40	1"	114,00	151,00	
<i>PKM 65</i>	<i>PK 65</i>	0,55	50-8	5-50	1"	177,00	199,00	
<i>PKM 80</i>	<i>PK 80</i>	0,75	66-22	5-50	1"	239,00	265,00	
<i>PKM 90</i>	<i>PK 90</i>	0,75	82-5	5-40	3/4"	287,00	314,00	
<i>PKM 100</i>	<i>PK 100</i>	1,1	80-15	5-70	1"	434,00	450,00	
<i>PKM 200</i>	<i>PK 200</i>	1,5	86-10	5-80	1"	466,00	481,00	
<i>PKM 300</i>	<i>PK 300</i>	2,2	95-10	5-90	1"	514,00	514,00	
<i>PKSM 60</i>	<i>PKS 60</i>	0,37	38-5	5-40	1"	145,00	171,00	
<i>PKSM 65</i>	<i>PKS 65</i>	0,50	50-8	5-50	1"	217,00	238,00	
<i>PKSM 70</i>	<i>PKS 70</i>	0,60	62-18	5-50	1"	260,00	281,00	
<i>PKSM 80</i>	<i>PKS 80</i>	0,75	66-22	5-50	1"	274,00	297,00	
<i>PQM 60</i>	<i>PQ 60</i>	0,30	38-5	5-40	1"	129,00	151,00	
<i>PQM 61</i>	<i>PQ 61</i>	0,30	38-5	5-40	1/2"	129,00	151,00	
<i>PQM 65</i>	<i>PQ 65</i>	0,55	50-8	5-50	1"	193,00	217,00	
<i>PQM 80</i>	<i>PQ 80</i>	0,75	66-22	5-50	1"	265,00	289,00	
<i>PQM 90</i>	<i>PQ 90</i>	0,75	82-5	5-40	3/4"	287,00	314,00	
<i>PQM 100</i>	<i>PQ 100</i>	1,1	80-15	5-70	1"	435,00	450,00	
<i>PQM 200</i>	<i>PQ 200</i>	1,5	86-10	5-80	1"	464,00	464,00	
<i>PQM 300</i>	<i>PQ 300</i>	2,2	95-10	5-90	1"	499,00	499,00	
<i>FUTURE JETM1C</i>	<i>FUTURE JET1C</i>	0,37	30,5-3	5-90	1"	220,00	245,00	
<i>FUTURE JETM1B</i>	<i>FUTURE JET1B</i>	0,48	36-5,5	5-95	1"	226,00	251,00	
<i>FUTURE JETM1A</i>	<i>FUTURE JET1A</i>	0,55	44-9	5-100	1"	235,00	264,00	
<i>FUTURE JETM2C</i>	<i>FUTURE JET2C</i>	0,75	52-10	5-120	1"	249,00	272,00	
<i>FUTURE JETM2A</i>	<i>FUTURE JET2A</i>	0,9	56-13,7	5-120	1"	274,00	392,00	
<i>FUTURE JETM2AH</i>	<i>FUTURE JET2AH</i>	0,9	66-15	5-95	1"	299,00	309,00	
<i>FUTURE JETM1CX</i>	<i>FUTURE JET1CX</i>	0,37	30,5-3	5-90	1"	191,00	213,00	
<i>FUTURE JETM1BX</i>	<i>FUTURE JET1BX</i>	0,48	36-5,5	5-95	1"	170,00	232,00	
<i>FUTURE JETM1AX</i>	<i>FUTURE JET1AX</i>	0,55	44-9	5-100	1"	175,00	235,00	
<i>FUTURE JETM2CX</i>	<i>FUTURE JET2CX</i>	0,75	52-10	5-120	1"	220,00	275,00	
<i>FUTURE JETM2AX</i>	<i>FUTURE JET2AX</i>	0,9	56-13,7	5-120	1"	269,00	302,00	
<i>FUTURE JETM1C-ST</i>	<i>FUTURE JET1CST</i>	0,37	30-3,5	5-90	1"	243,00	268,00	
<i>FUTURE JETM1B-ST</i>	<i>FUTURE JET1BST</i>	0,48	36-5,5	5-95	1"	246,00	272,00	
<i>FUTURE JETM1A-ST</i>	<i>FUTURE JET1AST</i>	0,55	44-9	5-100	1"	256,00	281,00	
<i>FUTURE JETM2C-ST</i>	<i>FUTURE JET2CST</i>	0,75	52-10	5-120	1"	293,00	304,00	
<i>FUTURE JETM2A-ST</i>	<i>FUTURE JET2AST</i>	0,9	56-13,7	5-120	1"	319,00	331,00	
<i>JSWM 3CH</i>	<i>JSW 3CH</i>	1,1	55-30	10-80	1 1/4"/1"	514,00	531,00	
<i>JSWM 3BH</i>	<i>JSW 3BH</i>	1,5	68-38	10-80	1 1/4"/1"	545,00	545,00	
<i>JSWM 3AH</i>	<i>JSW 3AH</i>	2,2	88-52	10-80	1 1/4"/1"	613,00	561,00	
<i>JSWM 3CM</i>	<i>JSW 3CM</i>	1,1	46-20	10-120	1 1/4"/1"	514,00	531,00	
<i>JSWM 3BM</i>	<i>JSW 3BM</i>	1,5	56-30	10-120	1 1/4"/1"	556,00	545,00	
<i>JSWM 3AM</i>	<i>JSW 3AM</i>	2,2	70-40	10-120	1 1/4"/1"	613,00	561,00	
<i>JSWM 3CL</i>	<i>JSW 3CL</i>	1,1	39-14	10-160	1 1/4"/1"	514,00	531,00	
<i>JSWM 3BL</i>	<i>JSW 3BL</i>	1,5	46-24	10-160	1 1/4"/1"	556,00	545,00	
<i>JSWM 3AL</i>	<i>JSW 3AL</i>	2,2	58-36	10-160	1 1/4"/1"	613,00	569,00	
<i>JDWM1AX/30-4</i>	-	0,75	50-20	2-24	1"	302,00	-	
<i>JDWM2A/30- 4"</i>	-	1,1	75-30	2-28	1"	450,00	-	





Vandens siurbliai PEDROLLO





Markė 230 V	Markė 400 V	P, kW	H, m	Q, l/min	Pajungim.	Kaina 230 V	Kaina 400 V	
CPM 100	CP 100	0,25	15-7	10-60	1"	175,00	199,00	
CPM 130	CP 130	0,37	22-14	10-80	1"	190,00	214,00	
CPM 132	CP 132	0,60	22-9	20-120	1"	217,00	239,00	
CPM 150	CP 150	0,75	29-15	20-120	1"	250,00	274,00	
CPM 158	CP 158	0,75	34-25	10-90	1"	250,00	274,00	
CPM 170	CP 170	1,1	38-22	30-120	1 1/4" / 1"	428,00	442,00	
CPM 170M	CP 170M	1,1	35-19	30-160	1 1/4" / 1"	442,00	458,00	
CPM 190	CP 190	1,5	46-26	30-140	1 1/4" / 1"	531,00	531,00	
CPM 200	CP 200	2,2	55-36	30-150	1 1/4" / 1"	561,00	561,00	
CPM 160C	CP 160C	1,1	31-20	20-200	1 1/2" / 1"	494,00	513,00	
CPM 160B	CP 160B	1,5	36-23	20-220	1 1/2" / 1"	531,00	531,00	
CPM 160A	CP 160A	2,2	42-26	50-240	1 1/2" / 1"	547,00	547,00	
—	CP 210B	3	53-34	50-270	1 1/2" / 1"	—	928,00	
—	CP 210A	4	59,5-39	20-280	1 1/2" / 1"	—	976,00	
CPM 220C	CP 220C	2,2	31-21	50-450	2"	899,00	691,00	
—	CP 220B	3	37-25	50-450	2"	—	821,00	
—	CP 220A	4	48-36	50-450	2"	—	997,00	
—	CP 220AH	5,5	51-42	100-850	2"	—	1060,0	
—	CP 230C	3	29-9	100-900	2"	—	821,00	
—	CP 230B	4	38-13	100-900	2"	—	997,00	
—	CP 230A	5,5	45-15	100-900	2"	—	1060,0	
—	CP 250B	7,5	60-26,5	100-900	2"	—	1378,0	
—	CP250A	11	77,5-42	100-900	2"	—	2230,0	
HFM 50B	HF 50B	0,37	10-4	50-300	1 1/2"	239,00	265,00	
HFM 50A	HF 50A	0,55	12-6	50-300	1 1/2"	260,00	281,00	
HFM 51B	HF 51B	0,6	17,2-5,4	50-300	1 1/2"	289,00	314,00	
HFM 51A	HF 51A	0,75	20,2-8,4	50-300	1 1/2"	299,00	320,00	
HFM 70C	HF 70C	1,1	28-15	50-300	1 1/2"	473,00	491,00	
HFM 70B	HF 70B	1,5	32-19	50-300	1 1/2"	499,00	499,00	
HFM 5B	HF 5B	0,75	13-5	100-500	2"	307,00	330,00	
HFM 5A	HF 5A	0,75	15,4-4,3	100-600	2"	320,00	338,00	
HFM 5BM	HF 5BM	1,1	18,5-6	100-600	2"	458,00	473,00	
HFM 5AM	HF 5AM	1,5	21,5-10	100-600	2"	481,00	481,00	
HFM 5ARM	HF 5ARM	2,2	23-10	100-700	2"	530,00	530,00	
HFM 4	HF 4	0,75	9,3-3	200-800	2 1/2"	329,00	354,00	
HFM 6C	HF 6C	1,1	11,7-3	200-1000	3"	531,00	545,00	
HFM 6B	HF 6B	1,5	14,5-5	200-1100	3"	561,00	561,00	
HFM 6A	HF 6A	2,2	18,1-6	200-1200	3"	—	586,00	
—	HF 8B	3	21-9	200-1200	4"	—	908,00	
—	HF 8A	4	24-13	200-1200	4"	—	977,00	
—	HF 20B	3	19-8	400-1600	4"	—	908,00	
—	HF 20A	4	21,5-6	400-1800	4"	—	977,00	
—	HF 30B	5,5	18-13	600-2000	4"	—	1205,0	
—	HF 30A	7,5	23-18	600-2200	4"	—	1267,0	
2CPM 25/130	2CP 25/130	0,75	39-15	20-100	1 1/4" / 1"	354,00	379,00	
TURBO M4B	TURBO 4B	1,1	50-25	20-120	1 1/4" / 1"	514,00	531,00	
TURBO M4A	TURBO 4A	1,5	65-31	20-140	1 1/4" / 1"	603,00	618,00	
TURBO M6C	TURBO 6C	1,1	47-13	20-160	1 1/4" / 1"	572,00	582,00	
TURBO M6B	TURBO 6B	1,5	56-20	20-180	1 1/4" / 1"	618,00	618,00	
TURBO M6A	TURBO 6A	2,2	66,5-21	20-200	1 1/4" / 1"	700,00	664,00	
—	2CP 32/200C	3	67-36	40-250	1 1/2" / 1 1/4"	—	1118,0	
—	2CP 32/200B	4	81-49	40-250	1 1/2" / 1 1/4"	—	1159,0	
—	2CP 32/210B	5,5	94-56	40-250	2" / 1 1/4"	—	1293,0	
—	2CP 32/210A	7,5	111-74	40-250	2" / 1 1/4"	—	1363,0	
—	2CP 40/180C	4	62-35	100-350	2" / 1 1/2"	—	1254,0	
—	2CP 40/180B	5,5	78-42	100-400	2" / 1 1/2"	—	1301,0	
—	2CP 40/180A	7,5	90-48	100-400	2" / 1 1/2"	—	1366,0	
—	2CP 40/200B	9,2	95-61	100-450	2" / 1 1/2"	—	2291,0	
—	2CP 40/200A	11	105-71	100-450	2" / 1 1/2"	—	2329,0	

Vandens siurbliai PEDROLLO





Markė 230 V	Markė 400 V	P, kW	H, m	Q, l/min	Pajungimai	Kaina 230 V	Kaina 400 V	
PKSM 60	PKS 60	0,37	38-5	5-40	1"	166,00	192,00	
PKSM 65	PKS65	0,55	50-8	5-50	1"	214,00	239,00	
PKSM 80	PKS 80	0,75	66-22	5-50	1"	284,00	310,00	
CKM 50	CK 50	0,37	31-5	5-40	3/4"	238,00	265,00	
CKM 50-BP	CK 50-BP	0,25	20-5	5-40	3/4"	337,00	289,00	
CKRM 90	CKR 90	0,75	55-7	5-50	1"	368,00	393,00	
2CPM 80	2CP 80	0,30	26-5	5-70	1"	217,00	239,00	
3CPM 80	3CP 80	0,45	38-5	5-80	1"	233,00	260,00	
4CPM 80	4CP 80	0,55	50-10	5-80	1"	260,00	281,00	
3CPM 100	3CP 100	0,55	37-5	5-120	1"	260,00	281,00	
4CPM 100	4CP 100	0,75	50-5	5-130	1"	299,00	320,00	



Vandens siurbliai su atviru darbo ratu PEDROLLO

Markė 230 V	Markė 400 V	P, kW	H, m	Q, l/min	Pajungimai	Kaina 230 V	Kaina 400 V	
NGAM 1B	NGA 1B	0,55	17-8	50-300	1 1/2"	320,00	346,00	
NGAM 1A	NGA 1A	0,75	19,5-6	50-350	1 1/2"	330,00	354,00	
NGAM 2B	NGA 2B	0,55	9,4-4	50-450	1 1/2"	320,00	346,00	
NGAM 2A	NGA 2A	0,75	10,8-4	50-550	1 1/2"	330,00	354,00	
NGAM 3D	NGA 3D	1,1	12-5	100-700	2"	662,00	662,00	
NGAM 3C	NGA 3C	1,5	14,4-5,7	100-770	2"	717,00	717,00	
NGAM 3B	NGA 3B	1,8	16,5-7	100-840	2"	745,00	745,00	
NGAM 3A	NGA 3A	2,2	19-8,5	100-900	2"	774,00	774,00	
NGAM 1B-PRO	NGA 1B-PRO	0,55	17-8	50-300	1 1/2"	675,00	697,00	
NGAM 1A-PRO	NGA 1A-PRO	0,75	19,5-6	50-350	1 1/2"	691,00	713,00	
NGAM 2B-PRO	NGA 2B-PRO	0,55	9,4-4	50-450	1 1/2"	675,00	697,00	
NGAM 2A-PRO	NGA 2A-PRO	0,75	10,8-4	50-550	1 1/2"	691,00	713,00	
NGAM 3D-PRO	NGA 3D-PRO	1,1	12-5	100-700	2"	1192,0	1192,0	
NGAM 3C-PRO	NGA 3C-PRO	1,5	14,4-5,7	100-770	2"	1220,0	1220,0	
NGAM 3B-PRO	NGA 3B-PRO	1,8	16,5-7	100-840	2"	1247,0	1247,0	
NGAM 3A-PRO	NGA 3A-PRO	2,2	19-8,5	100-900	2"	1273,0	1273,0	



Pramoniniai siurbliai PEDROLLO

Markė 230 V	Markė 400 V	P, kW	H, m	Q, l/min	Pajungimai	Kaina 230 V	Kaina 400 V	
PQM 60-BS	PQ 60-BS	0,30	43-5	2-40	1"	259,00	283,00	
PQM 65-BS	PQ 65-BS	0,55	54-8	2-50	1"	366,00	391,00	
PQM 81-BS	PQ 81-BS	0,55	92-10	1-20	1/2"	374,00	397,00	
PQAM 60	PQA 60	0,30	38-5	2-32	1/2"	229,00	255,00	
PQAM 70	PQA 70	0,55	65-10	2-45	1/2"	363,00	387,00	
PQAM 90	PQA 90	0,75	86-6	2-38	1/2"	391,00	416,00	
PVM 55	PV 55	0,18	35-5	2-10	1/4"	227,00	251,00	
PVM 60	PV 60	0,37	41-6	2-33	1/2"	351,00	376,00	
PVM 81	PV 81	0,37	75-6	2-17	1/2"	376,00	397,00	
PVM 65	PV 65	0,60	55-7	2-40	3/4"	386,00	408,00	
PVM 70	PV 70	0,90	70-7	2-45	3/4"	412,00	433,00	
PVM 90	PV 90	0,90	98-7	2-36	3/4"	438,00	464,00	
PQM81-PPS	PQ81-PPS	0,55	83.5-10	2-22	1/2"	330,00	351,00	
-	PQ 3000	2,2	180-50	5-50	3/4"	-	886,00	
-	PQ 3000 - MF	2,2	180-50	5-50	3/4"	-	1040,0	

Horizontalūs daugiapakopiai vandens siurbliai PEDROLLO**Nerūdyjancio plieno AISI 304 darbo ratai**

Markė 230 V	Markė 400 V	P, kW	H, m	Q, l/min	Pajungimai	Kaina 230 V	Kaina 400 V	
PLURIJET M3/80	PLURIJET 3/80	0,48	38-5	5-80	1"	298,00	323,00	
PLURIJET M4/80	PLURIJET 4/80	0,55	50-10	5-80	1"	329,00	353,00	
PLURIJET M3/100	PLURIJET 3/100	0,55	37-5	5-120	1"	329,00	353,00	
PLURIJET M4/100	PLURIJET 4/100	0,75	50-5	5-130	1"	374,00	386,00	
PLURIJET M3/90	PLURIJET 3/90	0,48	38-5	5-80	1"	350,00	374,00	
PLURIJET M4/90	PLURIJET 4/90	0,55	50-10	5-80	1"	385,00	409,00	
PLURIJET M5/90	PLURIJET 5/90	1,1	78-38	5-90	1 1/4" / 1"	839,00	852,00	
PLURIJET M6/90	PLURIJET 6/90	1,5	94-45	5-90	1 1/4" / 1"	908,00	908,00	
PLURIJET M3/120	PLURIJET 3/120	0,55	37-5	5-120	1"	385,00	409,00	
PLURIJET M4/120	PLURIJET 4/120	0,75	50-5	5-130	1"	419,00	431,00	
PLURIJET M3/130	PLURIJET 3/130	1,1	49-24	5-130	1 1/4" / 1"	839,00	852,00	
PLURIJET M4/130	PLURIJET 4/130	1,5	65-31	5-130	1 1/4" / 1"	908,00	908,00	
PLURIJET M5/130	PLURIJET 5/130	1,8	81-39	5-130	1 1/4" / 1"	963,00	943,00	
PLURIJET M6/130	PLURIJET 6/130	2,2	97-46	5-130	1 1/4" / 1"	995,00	990,00	
PLURIJET M3/200	PLURIJET 3/200	1,1	43-13	20-200	1 1/4" / 1"	839,00	852,00	
PLURIJET M4/200	PLURIJET 4/200	1,5	57-17	20-200	1 1/4" / 1"	908,00	908,00	
PLURIJET M5/200	PLURIJET 5/200	1,8	71-22	20-200	1 1/4" / 1"	943,00	943,00	
PLURIJET M6/200	PLURIJET 6/200	2,2	85-26	20-200	1 1/4" / 1"	990,00	990,00	
2CRM 80	2CR 80	0,37	26-5	5-70	1"	268,00	295,00	
3CRM 80	3CR 80	0,45	38-5	5-80	1"	290,00	316,00	
4CRM 80	4CR 80	0,55	50-10	5-80	1"	321,00	347,00	
5CRM 80	5CR 80	0,75	66-12	5-80	1"	376,00	392,00	
3CRM 100	3CR 100	0,55	37-5	5-120	1"	303,00	329,00	
4CRM 100	4CR 100	0,75	50-5	5-130	1"	371,00	384,00	
5CRM 100	5CR 100	1,1	62,8	5-130	1"	394,00	394,00	



Darbo ratai iš technopolimero

Markė 230 V	Markė 400 V	P, kW	H, m	Q, l/min	Pajungimai	Kaina 230 V	Kaina 400 V	
2CRM 80X	2CR 80X	0,37	26-5	5-70	1"	238,00	265,00	
3CRM 80X	3CR 80X	0,45	38-5	5-80	1"	259,00	274,00	
4CRM 80X	4CR 80X	0,6	50-10	5-80	1"	274,00	299,00	
3CRM 100X	3CR 100X	0,6	37-5	5-120	1"	274,00	299,00	
4CRM 100X	4CR 100X	0,75	50-5	5-130	1"	333,00	352,00	
PLURIJET M3/80X	PLURIJET 3/80X	0,48	38-5	5-80	1"	271,00	293,00	
PLURIJET M4/80X	PLURIJET 4/80X	0,55	50-10	5-80	1"	293,00	316,00	
PLURIJET M3/100X	PLURIJET 3/100X	0,55	37-5	5-120	1"	293,00	316,00	
PLURIJET M4/100X	PLURIJET 4/100X	0,75	50-5	5-130	1"	342,00	361,00	

Horizontalūs daugiapakopiai vandens siurbliai FCR

Nerūdijančio plieno AISI 304 darbo ratai



Markė 230 V	Markė 400 V	P, kW	H, m	Q, l/min	Pajungimai	Kaina 230 V	Kaina 400 V	
FCRM 80/2	FCR 80/2	0,30	26-5	5-70	1" / 1"	368,00	391,00	
FCRM 80/3	FCR 80/3	0,45	38-5	5-80		379,00	403,00	
FCRM 80/4	FCR 80/4	0,55	50-10	5-80		415,00	439,00	
FCRM 80/5	FCR 80/5	0,75	66-12	5-80		468,00	480,00	
FCRM 100/3	FCR 100/3	0,55	37-5	5-120		415,00	439,00	
FCRM 100/4	FCR 100/4	0,75	50-5	5-130		468,00	480,00	
FCRM 100/5	FCR 100/5	0,90	62-8	5-130		491,00	504,00	
FCRM 90/5	FCR 90/5	1,1	80-44	5-90	1 1/4" / 1"	907,00	919,00	
FCRM 90/6	FCR 90/6	1,5	96-52	5-90		984,00	984,00	
FCRM 90/7	FCR 90/7	1,8	112-61	5-90		1072,00	1072,00	
FCRM 130/3	FCR 130/3	1,1	51,5-31	5-130		805,00	820,00	
FCRM 130/4	FCR 130/4	1,5	68-41	5-130		883,00	883,00	
FCRM 130/5	FCR 130/5	1,8	85-51	5-130		960,00	960,00	
FCRM 130/6	FCR 130/6	2,2	103-62	5-130		1096,00	1042,00	
FCRM 200/3	FCR 200/3	1,1	46-17	20-200		805,00	820,00	
FCRM 200/4	FCR 200/4	1,5	62-23	20-200		883,00	883,00	
FCRM 200/5	FCR 200/5	1,8	77-28	20-200		960,00	960,00	
FCRM 200/6	FCR 200/6	2,2	93-34	20-200		1096,00	1042,00	
FCRM 240/3	FCR 240/3	1,5	46-11	20-240		883,00	883,00	
FCRM 240/4	FCR 240/4	1,8	61-15	20-240	960,00	960,00		
FCRM 240/5	FCR 240/5	2,2	76-19	20-240	1096,00	1042,00		
-	FCR 15/2R	2,2	43-20	50-350	-	1552,00		
-	FCR 15/3R	3	62-27	50-350	-	1676,00		
-	FCR 15/3	4	70-27	50-400	-	1742,00		
-	FCR 15/4	5,5	94-36	50-400	-	2055,00		
-	FCR 15/4	7,5	117-45	50-400	-	2334,00		
-	FCR 30/2R	3	34-10	100-700	2 1/2" / 2"	-	1552,00	
-	FCR 30/2	4	39-8	100-800		-	1676,00	
-	FCR 30/3	5,5	58-12	100-800		-	2055,00	
-	FCR 30/4	7,5	78-16	100-800		-	2334,00	

Giranti in acciaio Innox AISI 304

Flanšų komplektai siurbliams FCR

Kodas	Siurbliams	DN1	DN2	Kaina	
ASS14FL0001	FCR 80-100	DN25 (1")	DN25 (1")	66,00	
ASS14FL0002	FCR 90-130-200-240	DN32 (1 1/4")	DN25 (1")	70,00	
ASS14FL0003	FCR 15-30	DN65 (2 1/2")	DN50 (2")	125,00	

Flange in acciaio Innox AISI 304
(a richiesta)

Vertikalūs vandens siurbliai PEDROLLO

Markė 230 V	Markė 400 V	P, kW	H, m	Q, l/min	Pajungimai	Kaina 230 V	Kaina 400 V	
MKM 3/3	MK 3/3	0,75	51,5-29	10-80	1 1/4" / 1"	662,00	677,00	
MKM 3/5	MK 3/5	1,1	85-48	10-80		713,00	731,00	
MKM 3/6	MK 3/6	1,5	103-58	10-80		755,00	755,00	
MKM 5/4	MK 5/4	0,75	54-17	20-120	1 1/4" / 1"	693,00	708,00	
MKM 5/5	MK 5/5	1,1	67,5-21	20-120		713,00	731,00	
MKM 5/7	MK 5/7	1,5	95-30	20-120		783,00	783,00	
MKM 5/8	MK 5/8	2,2	108-34	20-120		852,00	798,00	
MKM 8/4	MK 8/4	1,3	53,5-12	40-180	1 1/4" / 1"	723,00	723,00	
MKM 8/5	MK 8/5	1,5	67-15,5	40-180		755,00	755,00	
MKM 8/6	MK 8/6	2,2	80-18,5	40-180		823,00	770,00	

Vertikalūs vandens siurbliai su nerūdyjančio plieno ratais



Markė 230 V	Markė 400 V	P, kW	H, m	Q, l/min	Pajungimai	Kaina 230 V	Kaina 400 V
HTM 3/4	HT 3/4	0,75	65-35	5-90	DN25 1" / 1"	1070,00	1098,00
HTM 3/5	HT 3/5	1,1	80-44	5-90		1108,00	1133,00
HTM 3/6	HT 3/6	1,5	96-52	5-90		1190,00	1190,00
HTM 3/7	HT 3/7	1,8	112-61	5-90		1281,00	1281,00
-	HT 3/8	2,2	128-69	5-90		-	1960,00
-	HT 3/9	3	144-78	5-90		-	2036,00
-	HT 3/10	3	160-87	5-90		-	2149,00
HTM 5/2	HT 5/2	0,75	35-20,5	5-130	DN32 1 1/4" / 1 1/4"	1070,00	1098,00
HTM 5/3	HT 5/3	1,1	51,5-31	5-130		1108,00	1133,00
HTM 5/4	HT 5/4	1,5	68,5-41	5-130		1190,00	1190,00
HTM 5/5	HT 5/5	1,8	85-51,5	5-130		1281,00	1281,00
HTM 5/6	HT 5/6	2,2	103-62	5-130		1338,00	1342,00
-	HT 5/7	3	120-72	5-130		-	1842,00
-	HT 5/8	3	137-82	5-130		-	1998,00
-	HT 5/9	4	154-93	5-130	-	2085,00	
HTM 8/3	HT 8/3	1,1	46,5-17	20-200	DN40 1 1/2" / 1 1/2"	1108,00	1133,00
HTM 8/4	HT 8/4	1,5	62-23	20-200		1190,00	1205,00
HTM 8/5	HT 8/5	1,8	77,5-28	20-200		1281,00	1292,00
HTM 8/6	HT 8/6	2,2	93-34,5	20-200		1338,00	1349,00
-	HT 8/7	3	108-40	20-200		-	1835,00
-	HT 8/8	4	124-45	20-200		-	1990,00
-	HT 8/9	4	139-51	20-200		-	2073,00
-	HT 8/10	5,5	155-57	20-200	-	2232,00	
HTM 10/3	HT 10/3	1,5	45,5-13	30-250	DN40 1 1/2" / 1 1/2"	1190,00	1190,00
HTM 10/4	HT 10/4	1,8	61-18	30-250		1281,00	1281,00
HTM 10/5	HT 10/5	2,2	75-21,5	30-250		1338,00	1338,00
-	HT 10/6	3	91-26	30-250		-	1804,00
-	HT 10/7	3	106-30	30-250		-	1853,00
-	HT 10/8	4	121-34	30-250		-	2036,00
-	HT 10/9	4	136-38	30-250		-	2094,00
-	HT 15/2R	2,2	43-20,5	50-350	DN50 2" / 2"	-	1835,00
-	HT 15/3R	3	62-27	50-350		-	1967,00
-	HT 15/3	4	70-27	50-350		-	1998,00
-	HT 15/4	5,5	94-36	50-350		-	2232,00
-	HT 15/5	7,5	117-45	50-350		-	2391,00
-	HT 15/6	9,2	137-52	50-350		-	4033,00
-	HT 15/7	9,2	160-61	50-350		-	4161,00
-	HT 30/2R	3	34-10	100-700	DN65 2 1/2" / 2 1/2"	-	1864,00
-	HT 30/2	4	39-8	100-800		-	1885,00
-	HT 30/3	5,5	58-12	100-800		-	2091,00
-	HT 30/4	7,5	78-16	100-800		-	2292,00
-	HT 30/5	9,2	98-20	100-800		-	3945,00
-	HT 30/6	11	117-24	100-800		-	4079,00
-	HT 30/7	15	134-27	100-800		-	4347,00
-	HT 30/8	15	154-31	100-800	-	4470,00	







Flanšų komplektai siurbliams HT

Kodas	Siurbliams	DN1	DN2	Kaina
ASS14FL0252	HT3	DN25 (1")	DN25 (1")	48,00
ASS14FL0322	HT5	DN32 (1 1/4")	DN32 (1 1/4")	75,00
ASS14FL0402	HT8, HT10	DN40 (1 1/2")	DN40 (1 1/2")	81,00
ASS14FL0502	HT15	DN50 (2")	DN50 (2")	90,00
ASS14FL0652	HT30	DN65 (2 1/2")	DN65 (2 1/2")	102,00



Baseinų siurbliai PEDROLLO



Markė 230 V	Markė 400 V	P, kW	H, m	Q, l/min	Pajungi mai	Kaina 230 V	Kaina 400 V	
Baseinams iki 180m³								
MAGNIFICA 1M	MAGNIFICA 1	0,55	13,5-4	100-350	2"	519,00	544,00	
MAGNIFICA 2M	MAGNIFICA 2	0,75	16-4,5	100-400	2"	521,00	546,00	
MAGNIFICA 3M	MAGNIFICA 3	1,1	14,9-6	100-525	2"	682,00	682,00	
MAGNIFICA 4M	MAGNIFICA 4	1,5	17,3-7	100-600	2"	711,00	711,00	
MAGNIFICA 5M	MAGNIFICA 5	2,2	22,2-8	100-700	2"	759,00	759,00	
Baseinams iki 70m³								
PRIMA 33M	PRIMA 33	0,25	10,3-4	20-190	1 1/2"	465,00	488,00	
PRIMA 50M	PRIMA 50	0,37	11,6-4	20-220	1 1/2"	483,00	507,00	
PRIMA 75M	PRIMA 75	0,55	13,1-4	20-260	1 1/2"	494,00	519,00	
PRIMA100M	PRIMA100	0,75	15-4	20-290	1 1/2"	550,00	561,00	
PRIMA 150M	PRIMA 150	1,1	15,8-4	20-310	1 1/2"	627,00	639,00	
Baseinams iki 135 m³								
VILLABELLA 50M	VILLABELLA 50	0,37	14-4	50-300	2"	533,00	567,00	
VILLABELLA 75M	VILLABELLA 75	0,55	15,5-4	50-330	2"	573,00	612,00	
VILLABELLA 100M	VILLABELLA 100	0,75	16,4-4	50-400	2"	633,00	663,00	
VILLABELLA 150M	VILLABELLA 150	1,1	18,9-4	50-450	2"	690,00	702,00	
VILLABELLA 200M	VILLABELLA 200	1,5	19,9-4	50-570	2"	811,00	811,00	
VILLABELLA 300M	VILLABELLA 300	2,2	20,9-4	50-600	2"	952,00	865,00	
Baseinams iki 1080 m³								
-	MAXIMA 4/250	1,8	11,5-4	200-1000	2"	-	2328,0	
-	MAXIMA 4/300	2,2	12-4	200-1100	2"	-	2348,0	
-	MAXIMA 4/400	3	13,5-4	200-1250	2"	-	2390,0	
-	MAXIMA 4/550	4	12,5-5	200-2100	2"	-	2673,0	
-	MAXIMA 4/750	5,5	14,5-6	200-2300	2"	-	3600,0	
-	MAXIMA 4/1000	7,5	15,5-7	200-2400	2"	-	3852,0	

IN-LINE tipo flanšiniai cirkuliaciniai siurbliai WR



Nerūdijančio plieno AISI 304 darbo ratai, temperatūra -10°C --+90°C

Markė 230 V	Markė 400 V	P, kW	H, m	Q, l/min	Pajungimai	Kaina 230 V	Kaina 400 V	
WRM 40/125-SB	WR 40/125-SB	0,55	18,2-7	50-300	DN40/DN40	794,00	794,00	
WRM 40/125-SA	WR 40/125-SA	0,75	21,8-9	50-300	DN40/DN40	805,00	805,00	
WRM 50/125-SB	WR 50/125-SB	0,55	13,5-6	100-500	DN50/DN50	794,00	818,00	
WRM 50/125-SA	WR 50/125-SA	0,75	14,5-3,5	100-600		805,00	829,00	
WRM 50/125C	WR 50/125C	1,1	16-6	100-550		1232,0	1261,0	
WRM 50/125B	WR 50/125B	1,5	20,5-9	100-600		1261,0	1286,0	
WRM 50/125A	WR 50/125A	2,2	26-10	100-700		1303,0	1327,0	

Vandens siurbliai PEDROLLO su AISI 304 ner. plieno hidrauline dalimi

Markė 230 V	Markė 400 V	P, kW	H, m	Q, l/min	Pajungimai	Kaina 230 V	Kaina 400 V	
CPM 100-ST4	CP 100-ST4	0,25	15-6,5	10-90	1 1/4" / 1"	287,00	314,00	
CPM 130-ST4	CP 130-ST4	0,37	21,5-9	10-100	1 1/4" / 1"	301,00	327,00	
CPM 132-ST4	CP 132-ST4	0,55	23-12	20-120	1 1/4" / 1"	319,00	345,00	
CPM 150-ST4	CP 150-ST4	0,75	31-14	20-150	1 1/4" / 1"	369,00	382,00	
CPM 158-ST4	CP 158-ST4	0,75	35,5-19	10-120	1 1/4" / 1"	369,00	382,00	
CPM 170-ST4	CP 170-ST4	1,1	40-20	10-140	1 1/4" / 1"	503,00	516,00	
CPM 170M-ST4	CP 170M-ST4	1,1	35,5-19	20-160	1 1/4" / 1"	516,00	528,00	
CPM 180-ST4	CP 180-ST4	1,1	30-13	40-230	1 1/4" / 1"	528,00	542,00	
CPM 190-ST4	CP 190-ST4	1,5	35-16	40-250	1 1/4" / 1"	542,00	542,00	
CTM 200-ST4	CT 200-ST4	2,2	42-20	40-270	1 1/4" / 1"	583,00	583,00	



Vandens siurbliai PEDROLLO su AISI 316L ner. plieno hidrauline dalimi

Markė 230 V	Markė 400 V	P, kW	H, m	Q, l/min	Pajungimai	Kaina 230 V	Kaina 400 V	
CPM 100-ST6	CP 100-ST6	0,25	15-6,5	10-90	1 1/4" / 1"	381,00	409,00	
CPM 130-ST6	CP 130-ST6	0,37	21,5-9	10-100	1 1/4" / 1"	394,00	422,00	
CPM 132-ST6	CP 132-ST6	0,55	23-12	20-120	1 1/4" / 1"	404,00	431,00	
CPM 150-ST6	CP 150-ST6	0,75	31-14	20-150	1 1/4" / 1"	493,00	503,00	
CPM 158-ST6	CP 158-ST6	0,75	35,5-19	10-120	1 1/4" / 1"	493,00	503,00	
CPM 170-ST6	CP 170-ST6	1,1	40-20	10-140	1 1/4" / 1"	655,00	668,00	
CPM 170M-ST6	CP 170M-ST6	1,1	35,5-19	20-160	1 1/4" / 1"	668,00	682,00	
CPM 180-ST6	CP 180-ST6	1,1	30-13	40-230	1 1/4" / 1"	649,00	689,00	
CPM 190-ST6	CP 190-ST6	1,5	35-16	40-250	1 1/4" / 1"	662,00	689,00	
CTM 200-ST6	CT 200-ST6	2,2	42-20	40-270	1 1/4" / 1"	720,00	749,00	

Markė 230 V	Markė 400 V	P, kW	H, m	Q, l/min	Pajungi- mai	Kaina 230 V	Kaina 400 V	
Ebara DWO 200M	-	1,5	12,7-5,8	100 - 700	2 1/2" / 2"	595,00	-	
-	Ebara DWO 400	3,0	17,5-7,6	100 - 1100	3" / 2"	-	795,00	

Markė 230 V	Markė 400 V	P, kW	H, m	Q, l/min	Pajungim ai	Kaina 230 V	Kaina 400 V	
NGAM 1B-PRO	NGA 1B-PRO	0,55	17-8	50-300	1 1/2"	675,00	697,00	
NGAM 1A-PRO	NGA 1A-PRO	0,75	19,5-6	50-350	1 1/2"	691,00	713,00	
NGAM 2B-PRO	NGA 2B-PRO	0,55	9,4-4	50-450	1 1/2"	675,00	697,00	
NGAM 2A-PRO	NGA 2A-PRO	0,75	10,8-4	50-550	1 1/2"	691,00	713,00	
NGAM 3D-PRO	NGA 3D-PRO	1,1	12-5	100-700	2"	1192,0	1192,0	
NGAM 3C-PRO	NGA 3C-PRO	1,5	14,4-5,7	100-770	2"	1220,0	1220,0	
NGAM 3B-PRO	NGA 3B-PRO	1,8	16,5-7	100-840	2"	1247,0	1247,0	
NGAM 3A-PRO	NGA 3A-PRO	2,2	19-8,5	100-900	2"	1273,0	1273,0	

Flanšai AISI 316 siurbliams NGA, NGA-PRO

Kodas	Siurbliams	DN1	DN2	Kaina	
ASS14FL0004	NGA1, NGA2 NGA1-PRO, NGA2-PRO	40 / 1 1/2"	40 / 1 1/2"	95,00	 
ASS14FL0005	NGA3, NGA3-PRO	50 / 2"	50 / 2"	146,00	

Konsoliniai vandens siurbliai F (EN 733) 50Hz, n=2900 aps/min

Markė 230 V	Markė 400 V	P, kW	H, m	Q, l/min	Pajungimai	Kaina 230 V	Kaina 400 V	
FM 32/160C	F 32/160C	1,5	24-13	100-350	DN 50 / 32	894,00	861,00	
FM 32/160B	F 32/160B	2,2	30-16	100-400		1128,0	894,00	
—	F 32/160A	3	37-20	100-450		—	1024,00	
—	F 32/200C	4	44-31,5	100-450		—	1167,00	
—	F 32/200B	5,5	52-36	100-500		—	1230,00	
—	F 32/200A	7,5	57-44	100-500		—	1312,00	
—	F 32/200BH	3	45-28	100-300		—	1130,00	
—	F 32/200AH	4	55-38	100-300		—	1164,00	
—	F 32/250C	9,2	75-55	100-400		—	2404,00	
—	F 32/250B	11	87-62	100-450		—	2435,00	
—	F 32/250A	15	97-70	100-480		—	2581,00	
FM 40/125C	F 40/125C	1,1	16-6	100-550		DN 65 / 40	837,00	812,00
FM 40/125B	F 40/125B	1,5	20,5-9	100-600			845,00	845,00
—	F 40/125A	2,2	26-10	100-700	—		878,00	
FM 40/160C	F40/160C	2,2	27-14	100-600	1128,0		894,00	
—	F 40/160B	3	32-20	100-600	—		1025,00	
—	F 40/160A	4	38-20	100-700	—		1098,00	
—	F 40/200B	5,5	47-24	100-700	—		1312,00	
—	F 40/200A	7,5	54-32	100-700	—		1384,00	
—	F 40/250C	9,2	64-47	100-700	—		2509,00	
—	F 40/250B	11	71-55	100-700	—		2552,00	
—	F 40/250A	15	88-72	100-700	—		2699,00	
FM 50/125C	F 50/125C	2,2	17,5-6	300-1200	DN 65 / 50		1130,0	894,00
—	F 50/125B	3	20,7-9	300-1200			—	1025,00
—	F 50/125A	4	23,5-13	300-1200		—	1100,00	
—	F 50/160C	4	27-16	300-1000		—	1167,00	
—	F 50/160B	5,5	32-21	300-1100		—	1230,00	
—	F 50/160A	7,5	37-27	300-1100		—	1312,00	
—	F 50/200C	11	46-33	400-1600		—	2509,00	
—	F 50/200B	15	54-38	400-1700		—	2698,00	
—	F 50/200A	18,5	63-45	400-1800		—	2864,00	
—	F 50/200AR	22	69-53	400-1800		—	3067,00	
—	F 50/250D	9,2	51-32	300-900		—	2511,00	
—	F 50/250C	11	59-42	300-900		—	2583,00	
—	F 50/250B	15	72-59	300-1000		—	2698,00	
—	F 50/250A	18,5	85-73	300-1000		—	2864,00	
—	F 50/250AR	22	95-83	300-1000		—	3067,00	
—	F 65/125C	4	16-11	600-1800		DN 80 / 65	—	1312,00
—	F 65/125B	5,5	18-13	600-2000			—	1382,00
—	F 65/125A	7,5	23-18	600-2200	—		1433,00	
—	F 65/160C	9,2	32-22	600-2200	—		2509,00	
—	F 65/160B	11	36,5-23	600-2400	—		2526,00	
—	F 65/160A	15	40,5-28	600-2400	—		2697,00	
—	F 65/200B	15	46-35,5	400-2000	—		2747,00	
—	F 65/200A	18,5	52-40	400-2100	—		2914,00	
—	F 65/200AR	22	57-46	400-2100	—		3101,00	
—	F 65/250C	30	76-53	400-2350	—		6593,00	
—	F 65/250B	37	87-62	400-2500	—		7120,00	
—	F 65/250A	45	95-68	400-2600	—		7321,00	
—	F 80/160D	11	25-13	500-4000	DN 100 / 80		—	2579,00
—	F 80/160C	15	30-18	500-4000		—	2747,00	
—	F 80/160B	18,5	35-23	500-4000		—	2914,00	
—	F 80/160A	22	40-28	500-4000		—	3101,00	
—	F 80/200B	30	56-34,5	500-3900		—	7317,00	
—	F 80/200A	37	62-40	500-3900		—	7638,00	
—	F 80/250B	45	77-54	600-3900		—	7722,00	
—	F 80/250A	55	88,5-60	600-3900		—	15594,00	



Konsoliniai vandens siurbliai F (EN 733) 50Hz, n=2900 aps/min



Markė 230 V	Markė 400 V	P, kW	H, m	Q, l/min	Pajungimai	Kaina 230 V	Kaina 400 V
—	F 100/160C	15	28,5-11	1000-5000	DN125/100	—	2914,00
—	F 100/160B	18,5	32,5-11	1000-5500		—	3067,00
—	F 100/160A	22	37-13	1000-6000		—	3235,00
—	F 100/200C	30	51-28	833-4650		—	7477,00
—	F 100/200B	37	57-33	833-4900		—	7942,00
—	F 100/200A	45	63-38	833-5250		—	8024,00
—	F 100/250B	55	75-48	800-5150		—	17215,00
—	F 100/250A	75	89-58	800-5750		—	17600,00



F markės siurbliai atitinka EN 733 – DIN 24255 reikalavimus. **GARANTIJA SIURBLIAMS – 24 MĖNESIAI.**

Konsoliniai vandens siurbliai F4 (EN 733) 50Hz, n=1450 aps/min

Markė 400 V	P, kW	H, m	Q, l/min	Pajungimai	Kaina	
F4 32/160B	0.37	7.5-4.5	50-200	DN 50 / 32	924,00	
F4 32/160A	0.37	9-5	50-225		936,00	
F4 32/200B	0.75	12.5-9	50-250		1492,00	
F4 32/200A	1.1	14-10.5	20-250		1516,00	
F4 32/200BH	0.75	11.3-9.2	50-150		1492,00	
F4 32/200AH	0.75	13.8-11	50-160		1492,00	
F4 32/250C	1.1	18.5-13.5	50-200		1966,00	
F4 32/250B	1.5	21.5-15.5	50-225		2085,00	
F4 32/250A	2.2	24-16.5	50-250		2132,00	
F4 40/160B	0.37	7.5-3.5	50-320	DN 65 / 40	924,00	
F4 40/160A	0.55	9-4.5	50-350		936,00	
F4 40/200B	0.75	11.5-7	50-350		1540,00	
F4 40/200A	1.1	13.8-10	50-350		1564,00	
F4 40/250C	1.1	15.5-10	50-400		1943,00	
F4 40/250B	1.5	17.5-12	50-400		2061,00	
F4 40/250A	2.2	22-17	50-400		2132,00	
F4 50/125B	0.55	5-2	150-600	DN 65 / 50	971,00	
F4 50/125A	0.55	6-3	150-600		971,00	
F4 50/160B	0.75	8-3.8	150-650		1492,00	
F4 50/160A	1.1	9.3-4.5	150-700		1516,00	
F4 50/200C	1.5	11-7.5	200-850		2085,00	
F4 50/200B	2.2	13-9.5	200-850		2143,00	
F4 50/200A	2.2	15-11.2	200-900		2143,00	
F4 50/200AR	3.0	17-13.2	200-900		2191,00	
F4 50/250D	1.1	12.5-5	150-650		1895,00	
F4 50/250C	1.5	14-5	150-700		2014,00	
F4 50/250B	2.2	18-10.5	150-700		2085,00	
F4 50/250A	2.2	20-13	150-700		2085,00	
F4 50/250AR	3.0	23.5-17	150-700		2143,00	
F4 65/125B	0.75	4.7-3	300-1100		DN 80 / 65	1576,00
F4 65/125A	10.1	5.7-4	300-1200			1600,00
F4 65/160C	1.1	8-5.5	300-1100	1931,00		
F4 65/160B	1.5	9.1-5.7	300-1200	2014,00		
F4 65/160A	2.2	10.1-7	300-1200	2108,00		
F4 65/200A	2.2	12-8.5	300-1250	2192,00		
F4 65/200AR	3.0	14-10	300-1300	2251,00		
F4 65/250B	4.0	21.8-15.5	200-1250	3222,00		
F4 65/250A	5.5	23.5-17	200-1300	3269,00		



Konsoliniai vandens siurbliai F4 (EN 733) 50Hz, n=1450 aps/min



Markė 400 V	P, kW	H, m	Q, l/min	Pajungimai	Kaina
F4 80/160D	1.5	6.3-2.5	300-2000	DN 100 / 80	2085,00
F4 80/160C	2.2	7.5-3.8	300-2000		2144,00
F4 80/160B	2.2	8.8-5	300-2000		2144,00
F4 80/160A	3.0	10-6.2	300-2000		2192,00
F4 80/200B	4.0	14-9	300-1800		3222,00
F4 80/200A	5.5	15.5-10.5	300-1900		3269,00
F4 80/250B	5.5	19.5-13.5	300-1800		3980,00
F4 80/250A	7.5	22-15	30-1950		4158,00
F4 100/160B	2.2	8.1-2.7	400-2750	DN 125 / 100	2452,00
F4 100/160A	3.0	9.2-3.2	400-3000		2524,00
F4 100/200C	4.0	12.7-7	400-2300		3411,00
F4 100/200B	5.5	14.2-8.5	400-2400		3471,00
F4 100/200A	5.5	15.8-9.5	400-2600		3471,00
F4 100/250B	7.5	18.5-11.5	400-2600		4158,00
F4 100/250A	9.2	22-13.5	400-2900		4442,00



F markės siurbliai atitinka EN 733 – DIN 24255 reikalavimus. **GARANTIJA SIURBLIAMS – 24 MĖNESIAI.**

Konsoliniai nerūdyjančio plieno vandens siurbliai PEDROLLO F-INOX

Markė 400 V	P, kW	H, m	Q, l/min	Pajungimai	Kaina 400 V
F 50/160C-I	4	27-16	300-1000	DN 65 / 50	3950,00
F 50/160B-I	5,5	32-21	300-1100		4037,00
F 50/160A-I	7,5	37-27	300-1100		4110,00
F 65/125C-I	4	16-11	600-1800	DN 80 / 65	4715,00
F 65/125B-I	5,5	18-13	600-2000		4773,00
F 65/125A-I	7,5	23-18	600-2200		4842,00
F4 50/160B-I	0,75	8-3,8	150-650	DN 65 / 50	4290,00
F4 50/160A-I	1,1	9,3-4,5	150-700		4364,00
F4 65/125B-I	0,75	4,7-3	300-1100	DN 80 / 65	5023,00
F4 65/125A-I	1,1	5,7-4	300-1200		5095,00



hidraulinė dalis - nerūdyjančio plieno AISI 316

Flanšai konsolinams siurbliams F, F4

Kodas	Siurbliams	DN1	DN2	Kaina
ASS14FL0320	F32, F4 32	50 / 2"	32 / 1 1/4"	80,00
ASS14FL0400	F40, F4 40	65 / 2 1/2"	40 / 1 1/2"	88,00
ASS14FL0500	F50, F4 50	65 / 2 1/2"	50 / 2"	90,00
ASS14FL0650	F65, F4 65	80 / 3"	65 / 2 1/2"	103,00
ASS14FL0800	F80, F4 80	100 / 4"	80 / 3"	130,00
ASS14FL1000	F100, F4 100	125 / 5"	100 / 4"	160,00



Giluminiai siurbliai šuliniams PEDROLLO

Markė 230 V	Markė 400 V	Galia, kW	H, m	Q, m ³ /val	Kaina 230V, Eur	Kaina 400V, Eur
UPm 2/2 - GE	-	0,37	32 – 16,4	0,6 – 4,8	506,00	-
UPm 2/3 - GE	UP 2/3	0,55	47 – 24	0,6 – 4,8	525,00	537,00
UPm 2/4 - GE	UP 2/4	0,75	62,5 – 32	0,6 – 4,8	552,00	562,00
UPm 2/5 - GE	UP 2/5	1,1	78 – 40	0,6 – 4,8	584,00	595,00
UPm 2/6 - GE	UP 2/6	1,5	94 – 48	0,6 – 4,8	617,00	617,00
UPm 4/3 - GE	UP 4/3	0,55	39 – 12	1,2 – 7,2	525,00	537,00
UPm 4/4 - GE	UP 4/4	0,75	52 – 16	1,2 – 7,2	552,00	562,00
UPm 4/5 - GE	UP 4/5	1,1	65 – 20	1,2 – 7,2	584,00	595,00
UPm 4/6 - GE	UP 4/6	1,5	78 – 24	1,2 – 7,2	617,00	617,00
UPm 8/3 - GE	UP 8/3	1,1	39 – 9	2,4 – 10,8	584,00	595,00
UPm 8/4 - GE	UP 8/4	1,5	52 – 12	2,4 – 10,8	617,00	617,00
NKm 2/2 - GE	-	0,37	32 – 16,4	0,6 – 4,8	530,00	-
NKm 2/3 - GE	NK 2/3	0,55	47 – 24	0,6 – 4,8	549,00	560,00
NKm 2/4 - GE	NK 2/4	0,75	62,5 – 32	0,6 – 4,8	585,00	588,00
NKm 2/5 - GE	NK 2/5	1,1	78 – 40	0,6 – 4,8	630,00	606,00
NKm 2/6 - GE	NK 2/6	1,5	94 – 48	0,6 – 4,8	655,00	655,00
NKm 4/3 - GE	NK 4/3	0,55	39 – 12	1,2 – 7,2	549,00	560,00
NKm 4/4 - GE	NK 4/4	0,75	52 – 16	1,2 – 7,2	585,00	588,00
NKm 4/5 - GE	NK 4/5	1,1	65 – 20	1,2 – 7,2	630,00	606,00
NKm 4/6 - GE	NK 4/6	1,5	78 – 24	1,2 – 7,2	660,00	655,00
NKm 8/3 - GE	NK 8/3	1,1	39 – 16,2	2,4 – 9,6	630,00	606,00
NKm 8/4 - GE	NK 8/4	1,5	52 – 21,6	2,4 – 9,6	671,00	655,00



Markė 230V	Pastaba	Galia, kW	H, m	Q, m ³ /val	Kaina 230V, Eur
TOP MULTI 1	Su plūde, 10m kabeliu	0,37	6 - 25	4,5-0,6	249,00
TOP MULTI 2	Su plūde, 10m kabeliu	0,55	5 - 40	4,8-0,6	323,00
TOP MULTI 3	Su plūde, 10m kabeliu	0,75	4 - 32	7,2-0,6	363,00
TOP MULTI 4	Su plūde, 10m kabeliu	0,75	6 - 50	4,8-0,6	437,00
TOP MULTI 5	Su plūde, 10m kabeliu	0,75	6 - 40	7,2-0,6	476,00
TOP MULTI-TECH 2	Automatinis, 10m kab.	0,55	5 - 40	4,8-0,6	438,00
TOP MULTI-TECH 3	Automatinis, 10m kab.	0,55	4 - 32	7,2-0,6	471,00
TOP MULTI-TECH 4	Automatinis, 10m kab.	0,75	6 - 50	4,8-0,6	513,00
TOP MULTI-TECH 5	Automatinis, 10m kab.	0,75	6 - 40	7,2-0,6	556,00
TOP MULTI 1-EVO	Su plūde, 10m kabeliu	0,37	6 - 25	4,5-0,6	296,00
TOP MULTI 2-EVO	Su plūde, 10m kabeliu	0,55	5 - 40	4,8-0,6	387,00
TOP MULTI 3-EVO	Su plūde, 10m kabeliu	0,55	4 - 32	7,2-0,6	399,00
TOP MULTI 4-EVO	Su plūde, 10m kabeliu	0,75	6 - 50	4,8-0,6	488,00
TOP MULTI 5-EVO	Su plūde, 10m kabeliu	0,75	6 - 40	7,2-0,6	511,00
TOP MULTI-EVOTECH 2	Automatinis, 10m kab.	0,55	5 - 40	4,8-0,6	493,00
TOP MULTI-EVOTECH 3	Automatinis, 10m kab.	0,55	4 - 32	7,2-0,6	519,00
TOP MULTI-EVOTECH 4	Automatinis, 10m kab.	0,75	6 - 50	4,8-0,6	558,00
TOP MULTI-EVOTECH 5	Automatinis, 10m kab.	0,75	6 - 40	7,2-0,6	589,00



GARANTIJA SIURBLIAMS – 24 MĖNESIAI.

Laikiklis horizontaliam siurbliu UP-NK pajungimui

Kodas	Kaina, Eur
ASSKITUPFO	68,00

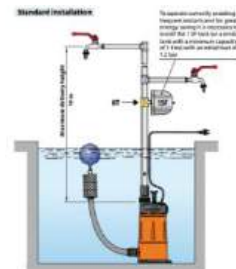

Siurblio pasiurbimo komplektas su plūduru

Kodas	Modelis	Pajungimo diam.	Kaina, Eur
ASSKITKGE	KGE	1 1/4"	92,00

Žarnos ilgis - 1,5 m.



Išsiplėtimo indas 0,5L

Kodas	Modelis	Pajungimo diam.	Kaina, Eur
50057005	1SF0.5	1/2"	54,00



4" PEDROLLO siurbliai grežiniams su plaukiojančiais darbo ratais

(Atitinka EU 547/2012, MEI ≥ 0,40)



Markė	Markė	Q, m ³ /val	H, m	P, kW	Kaina FRANKLIN, Eur su PVM		Kaina PEDROLLO, Eur su PVM	
					230 V	400 V	230 V	400 V
4SR1M/10S	4SR1/10S	0,3-1,8 (1,2)	69,5-32,5 (51)	0.37	732,00	732,00	569,00	569,00
4SR1M/15S	4SR1/15S	0,3-1,8 (1,2)	104-48,5 (78)	0.55	752,00	752,00	641,00	641,00
4SR1M/20S	4SR1/20S	0,3-1,8 (1,2)	139-65 (103)	0.75	867,00	867,00	742,00	742,00
4SR1M/29S	4SR1/29S	0,3-1,8 (1,2)	201-94 (150)	1.1	1145,00	1145,00	989,00	989,00
4SR1M/39S	4SR1/39S	0,3-1,8 (1,2)	271-127 (202)	1.5	1391,00	1366,00	1206,00	1163,00
4SR1.5M/7S	4SR1.5/7S	0,3-2,7 (1,5)	50-17 (40)	0.37	677,00	677,00	521,00	525,00
4SR1.5M/11S	4SR1.5/11S	0,3-2,7 (1,5)	78-26,5 (62,5)	0.55	684,00	699,00	587,00	599,00
4SR1.5M/15S	4SR1.5/15S	0,3-2,7 (1,5)	106-36 (84)	0.75	777,00	777,00	667,00	667,00
4SR1.5M/22S	4SR1.5/22S	0,3-2,7 (1,5)	154-52,5 (122)	1.1	1008,00	1008,00	864,00	853,00
4SR1.5M/30S	4SR1.5/30S	0,3-2,7 (1,5)	206-70 (164)	1.5	1170,00	1130,00	1006,00	962,00
4SR2M/6S	4SR2/6S	0,6-3,9 (2,4)	45-13 (33)	0.37	634,00	634,00	500,00	528,00
4SR2M/9S	4SR2/9S	0,6-3,9 (2,4)	67-19,5 (49,5)	0.55	671,00	684,00	489,00	553,00
4SR2M/12S	4SR2/12S	0,6-3,9 (2,4)	90-25,5 (66)	0.75	718,00	730,00	546,00	607,00
4SR2M/17S	4SR2/17S	0,6-3,9 (2,4)	127-36,5 (94)	1.1	840,00	857,00	703,00	702,00
4SR2M/23S	4SR2/23S	0,6-3,9 (2,4)	172-49 (127)	1.5	1168,00	1080,00	933,00	889,00
4SR2M/33S	4SR2/33S	0,6-3,9 (2,4)	246-71 (182)	2.2	—	1257,00	1136,00	1069,00
4SR4M/6S	4SR4/6S	1,2-6,0 (4,2)	45,5-17 (33)	0.55	697,00	697,00	574,00	560,00
4SR4M/8S	4SR4/8S	1,2-6,0 (4,2)	60,5-22,5 (44)	0.75	732,00	732,00	611,00	603,00
4SR4M/12S	4SR4/12S	1,2-6,0 (4,2)	91-33,5 (66)	1.1	838,00	855,00	694,00	692,00
4SR4M/15S	4SR4/15S	1,2-6,0 (4,2)	114-42 (83)	1.5	1055,00	968,00	837,00	791,00
4SR4M/22S	4SR4/22S	1,2-6,0 (4,2)	167-61,5 (121)	2.2	1569,00	1318,00	1114,00	1017,00
-	4SR4/30S	1,2-6,0 (4,2)	228-84 (165)	3.0	—	1442,00	—	1215,00
4SR6M/4S	4SR6/4S	1,5-9,0 (6,0)	25,5-9,5 (19,8)	0.55	769,00	769,00	633,00	618,00
4SR6M/6S	4SR6/6S	1,5-9,0 (6,0)	38-14,5 (29,5)	0.75	810,00	810,00	674,00	667,00
4SR6M/9S	4SR6/9S	1,5-9,0 (6,0)	57-21,5 (44,5)	1.1	934,00	934,00	769,00	754,00
4SR6M/13S	4SR6/13S	1,5-9,0 (6,0)	83-31,5 (64,5)	1.5	1155,00	1063,00	913,00	860,00
4SR6M/17S	4SR6/17S	1,5-9,0 (6,0)	108-41 (84)	2.2	1374,00	1347,00	1132,00	1024,00
—	4SR6/24S	1,5-9,0 (6,0)	152-58 (119)	3.0	—	1630,00	—	1471,00
—	4SR6/32S	1,5-9,0 (6,0)	203-77 (159)	4.0	—	2163,00	—	1729,00
4SR8M/4S	4SR8/4S	2,4-12 (8,4)	27-8 (19,4)	0.75	792,00	791,00	674,00	646,00
4SR8M/7S	4SR8/7S	2,4-12 (8,4)	47-14,5 (34)	1.1	913,00	913,00	769,00	731,00
4SR8M/9S	4SR8/9S	2,4-12 (8,4)	60-18,5 (43,5)	1.5	1100,00	1005,00	860,00	808,00
4SR8M/13S	4SR8/13S	2,4-12 (8,4)	87-26,5 (63)	2.2	1572,00	1301,00	1117,00	981,00
—	4SR8/17S	2,4-12 (8,4)	114-35 (82)	3.0	—	1545,00	—	1387,00
—	4SR8/24S	2,4-12 (8,4)	161-49 (116)	4.0	—	2044,00	—	1605,00
—	4SR8/32S	2,4-12 (8,4)	214-65 (155)	5.5	—	2390,00	—	1887,00
4SR10M/5-N	4SR10/5-N	3,0-15	29,5-6 (19)	0.75	873,00	836,00	695,00	695,00
4SR10M/7-N	4SR10/7-N	3,0-15	41-8,5 (26)	1.1	1040,00	951,00	749,00	749,00
4SR10M/9-N	4SR10/9-N	3,0-15	53-10,5 (34)	1.5	1269,00	1179,00	865,00	821,00
4SR10M/13-N	4SR10/13-N	3,0-15	77-15,5 (50)	2.2	1576,00	1492,00	1064,00	993,00
—	4SR10/18-N	3,0-15	106-21 (70)	3	—	1956,00	—	1280,00
—	4SR10/24-N	3,0-15	141-28,5 (93)	4	—	2070,00	—	1735,00
—	4SR10/32-N	3,0-15	189-38 (124)	5.5	—	2464,00	—	2115,00
—	4SR10/43-N	3,0-15	254-51 (166)	7.5	—	3188,00	—	2491,00
4SR12M/5-N	4SR12/5-N	3,0-18	26-6 (15,9)	0.75	871,00	836,00	798,00	798,00
4SR12M/7-N	4SR12/7-N	3,0-18	36,5-8,5 (22)	1.1	1052,00	959,00	930,00	852,00
4SR12M/9-N	4SR12/9-N	3,0-18	47-11 (28)	1.5	1269,00	1201,00	1055,00	1009,00
4SR12M/13-N	4SR12/13-N	3,0-18	68-15,5 (41)	2.2	1576,00	1473,00	1439,00	1324,00
—	4SR12/18-N	3,0-18	94-21,5 (57)	3	—	1909,00	—	1691,00
—	4SR12/24-N	3,0-18	126-29 (76)	4	—	2244,00	—	1962,00
—	4SR12/32-N	3,0-18	168-38,5 (101)	5.5	—	3247,00	—	2590,00
—	4SR12/40-N	3,0-18	210-48 (127)	7.5	—	3667,00	—	2956,00



4" PEDROLLO siurbliai gręžiniams su plaukiojančiais darbo ratais

(Atitinka EU 547/2012, MEI ≥ 0,40)



Markė 230 V	Markė 400 V	Q, m ³ /val	H, m	P, kW	Kaina FRANKLIN, Eur su PVM		Kaina PEDROLLO, Eur su PVM	
					230 V	400 V	230 V	400 V
4SR15M/6-N	4SR15/6-N	3,0-21	31,5-6 (17)	1.1	1065,00	973,00	942,00	863,00
4SR15M/8-N	4SR15/8-N	3,0-21	41,5-7,5 (23)	1.5	1222,00	1179,00	1166,00	989,00
4SR15M/12-N	4SR15/12-N	3,0-21	62,5-11,5 (33)	2.2	1561,00	1435,00	1401,00	1288,00
—	4SR15/16-N	3,0-21	83-15 (44)	3	—	1874,00	—	1663,00
—	4SR15/21-N	3,0-21	110-20 (58)	4	—	2221,00	—	1939,00
—	4SR15/29-N	3,0-21	151-28 (81)	5.5	—	3031,00	—	2380,00
—	4SR15/39-N	3,0-21	203-37,5 (109)	7.5	—	3559,00	—	2878,00

Pastaba: Darbo kreivių tolerancija atitinka EN ISO 9906 p.3B (Q ±9%, H±7%)
Stulpelyje Q ir H skliaustuose esantys skaičiai rodo slėgį prie nurodyto našumo.
GARANTIJA siurbliams: – 24 mėn.

4" PEDROLLO siurbliai gręžiniams su Franklin / Pedrollo varikliais

Markė 230 V	Markė 400 V	Q, m ³ /val	H, m	P, kW	Kaina FRANKLIN, Eur su PVM		Kaina PEDROLLO, Eur su PVM	
					230 V	400 V	230 V	400 V
4SR10M/5	4SR10/5	3,0-15 (10,5)	27-8 (21)	1.1	886,00	844,00	805,00	808,00
4SR10M/7	4SR10/7	3,0-15 (10,5)	47-14,5 (30)	1.5	1059,00	960,00	940,00	861,00
4SR10M/10	4SR10/10	3,0-15 (10,5)	60,5-18,5 (42)	2.2	1284,00	1198,00	1045,00	996,00
—	4SR10/15	3,0-15 (10,5)	87-26,5 (64)	3.0	—	1508,00	—	1360,00
—	4SR10/20	3,0-15 (10,5)	114-35 (85)	4.0	—	1975,00	—	1758,00
—	4SR10/26	3,0-15 (10,5)	161-49 (110)	5.5	—	2477,00	—	2193,00
—	4SR10/35	3,0-15 (10,5)	214-65,5 (148)	7.5	—	3356,00	—	2685,00
4SR12M/4	4SR12/4	3,0-18 (12)	24-8 (16)	1.1	764,00	844,00	805,00	808,00
4SR12M/6	4SR12/6	3,0-18 (12)	37-14 (28)	1.5	1059,00	968,00	940,00	861,00
4SR12M/9	4SR12/9	3,0-18 (12)	55-22 (42)	2.2	1284,00	1213,00	1067,00	1024,00
—	4SR12/12	3,0-18 (12)	73-29 (56)	3.0	—	1487,00	—	1341,00
—	4SR12/16	3,0-18 (12)	97-38 (75)	4.0	—	1926,00	—	1707,00
—	4SR12/22	3,0-18 (12)	135-53 (103)	5.5	—	2269,00	—	2050,00
—	4SR12/29	3,0-18 (12)	176-71 (135)	7.5	—	3285,00	—	2542,00
4SR15M/5	4SR15/5	3,0-22,5 (15)	30-7,5 (20)	1.5	1075,00	984,00	955,00	872,00
4SR15M/7	4SR15/7	3,0-22,5 (15)	42-10 (27)	2.2	1233,00	1193,00	1178,00	996,00
—	4SR15/10	3,0-22,5 (15)	60-15 (38)	3.0	—	1447,00	—	1304,00
—	4SR15/13	3,0-22,5 (15)	77-19 (50)	4.0	—	1893,00	—	1588,00
—	4SR15/18	3,0-22,5 (15)	108-27 (71)	5.5	—	2244,00	—	2024,00
—	4SR15/24	3,0-22,5 (15)	145-36 (95)	7.5	—	3065,00	—	2405,00

Pastaba: Darbo kreivių tolerancija atitinka EN ISO 9906 p.3B (Q ±9%, H±7%)
Stulpelyje Q ir H skliaustuose esantys skaičiai rodo slėgį prie nurodyto našumo.

4" LINZ Electric siurbliai gręžiniams su plaukiojančiais darbo ratais

Markė 230 V	Markė 400 V	Q, m ³ /val	H, m	P, kW	Kaina PEDROLLO, Eur su PVM	
					230 V	400 V
95LPRXM02N/14	95LPRX02N/14	1,2-3,6 (2,4)	80-31 (62)	0.75	482,00	640,00
95LPRXM02N/21	95LPRX02N/21	1,2-3,6 (2,4)	120-46 (93)	1.1	633,00	632,00
95LPRXM03N/14	95LPRX03N/14	1,2-5,4 (3,0)	91-25 (74)	1.1	625,00	624,00
95LPRXM04N/12	95LPRX04N/12	2,4-6,0 (4,2)	77-25 (60)	1.1	625,00	624,00

GARANTIJA siurbliams: – 24 mėn.

PEDROLLO giluminiai siurbliai su dvipoliais Franklin varikliais



Markė 230 V	Q, m ³ /val	H, m	P, kW	Kaina FRANKLIN
4SR1M/10S-R	0,3-1,8 (1,2)	67,5-31 (52)	0.37	695,00
4SR1M/15S-R	0,3-1,8 (1,2)	101-46,5 (78)	0.55	769,00
4SR2M/9S-R	0,6-3,9 (2,4)	67-19,5 (49,5)	0.55	709,00
4SR2M/12S-R	0,6-3,9 (2,4)	90-25,7 (66,2)	0.75	756,00
4SR2M/17S-R	0,6-3,9 (2,4)	127-36,4 (94)	1.1	865,00
4SR4M/12S-R	1,2-6,0 (4,2)	91-33,5 (66)	1.1	848,00

GARANTIJA SIURBLIAMS – 24 MĖNESIAI.

PEDROLLO monoblokiniai giluminiai siurbliai

Markė 230 V	Q, m ³ /val	H, m	P, kW	Kaina Eur
DAVIS*	0,3-2,4	68-19	0,75	436,00
4BLOCK M2/10	0,6-3,6 (2,0)	75-29,5 (60)	0.55	510,00
4BLOCK M2/13	0,6-3,6 (2,0)	97-38,5 (78)	0.75	540,00
4BLOCK M2/18	0,6-3,6 (2,0)	135-53,5 (109)	1.1	645,00
4BLOCK M4/13	1,2-6,0	97-32,5 (71,5)	1.1	645,00



Monoblokiniai giluminiai siurbliai su paleidimo kondensatoriumi ir šilumine apsauga viduje. Pultas nereikalingas. Maitinimo kabelio ilgis – 20 m. Smėlio kiekis vandenyje – iki 200 mg/l * - tik švariam vandeniui be smėlio priemaišų.

GARANTIJA SIURBLIAMS – 24 MĖNESIAI.

*Tik švariam vandeniui.

4" E-TECH giluminiai siurbliai



Franklin Electric

Markė 230 V	Markė 400 V	Q, m ³ /val	H, m	P, kW	Kaina su PEDROLLO Eur su PVM		Kaina su FRANKLIN, Eur su PVM	
					230 V	400 V	230 V	400 V
VS1M/13	VS1/13	0,3-1,5 (0,9)	71-20 (54)	0.37	407,00	407,00	514,00	504,00
VS2M/10	VS2/10	1,2-3,3 (2,1)	60-20 (49)	0.55	447,00	447,00	525,00	519,00
VS2M/14	VS2/14	1,2-3,3 (2,1)	85-27 (68)	0.75	484,00	484,00	574,00	563,00
VS2M/20	VS2/20	1,2-3,3 (2,1)	120-40 (97)	1.1	541,00	541,00	674,00	638,00
VS3M/15	VS3/15	1,0-4,2 (3,0)	97-35 (63)	1.1	546,00	546,00	663,00	626,00
VS4M/14	VS4/14	1,8-6,0 (4,2)	80-26 (59)	1.1	546,00	546,00	663,00	626,00
VS4M/18	VS4/18	1,8-6,0 (4,2)	104-34 (80)	1.5	622,00	564,00	794,00	751,00

GARANTIJA SIURBLIAMS – 24 MĖNESIAI.

SISTEMA (Taivanis) giluminiai siurbliai su SISTEMA arba PEDROLLO varikliais

Markė 230 V	Markė 400 V	Q, m ³ /val	H, m	P, kW	Kaina SISTEMA, Eur		Kaina PEDROLLO, Eur	
					230 V	400V	230V	400V
ST-0513M (1/10)	ST-0513 (1/10)	0,3 - 1,5	78 – 23 (56)	0,37	312,00	286,00	351,00	-
ST-0519M (1/15)	ST-0519 (1/15)	0,3 - 1,5	118 – 30 (86)	0,55	354,00	-	407,00	-
ST-1010M (2/9)	ST-1010 (2/9)	0,9 - 3,0	65 – 29 (55)	0,55	310,00	330,00	358,00	-
ST-1014M (2/12)	ST-1014 (2/12)	0,9 - 3,0	86 – 42 (74)	0,75	372,00	365,00	424,00	424,00
ST-1020M (2/17)	ST-1020 (2/17)	0,9 - 3,0	131 – 60 (111)	1,10	395,00	411,00	458,00	458,00
ST-1028M (2/23)	ST-1028 (2/23)	0,9 - 3,0	180 – 78 (138)	1,50	511,00	497,00	648,00	590,00
ST-1311M	ST-1311	1,2 – 4,2	68 – 26 (54)	0,75	348,00	347,00	412,00	414,00
ST-1316M	ST-1316	1,2 - 4,2	101 – 22 (77)	1,10	395,00	397,00	451,00	451,00
ST-1814M (4/12)	ST-1814 (4/12)	1,5 - 6,0	87 – 20 (68)	1,10	372,00	397,00	442,00	442,00
ST-1818M (4/15)	ST-1818 (4/15)	1,5 - 6,0	113 – 25 (88)	1,50	432,00	459,00	500,00	466,00
ST-1827M (4/22)	ST-1827 (4/22)	1,5 - 6,0	164 – 35 (109)	2,20	-	568,00	768,00	699,00
ST-3514M (6/13)	ST-3514 (6/13)	3,0 – 8,4	77 – 28 (59)	1,50	459,00	459,00	566,00	539,00
ST-3520M (6/17)	ST-3520 (6/17)	3,0 – 8,4	107 – 40 (80)	2,20	-	565,00	765,00	696,00
ST-4013M (8/13)	ST-4013 (8/13)	4,8 – 12,0	75 – 30 (59)	2,20	-	517,00	718,00	649,00
-	ST-4017 (8/17)	4,8 – 12,0	98 – 46 (79)	3,00	-	628,00	-	784,00
-	ST-4023 (8/24)	4,8 – 12,0	134 – 60 (143)	4,00	-	982,00	-	1049,00
-	ST-5524 (10/20)	4,8 – 14,4	118 – 33 (88)	4,00	-	1155,00	-	1222,00
-	ST-6019 (12/16)	6,0 – 16,0	102 – 37 (76)	4,00	-	1078,00	-	1145,00

GARANTIJA SIURBLIAMS – 24 MĖNESIAI.

SISTEMA (Taivanis) giluminių siurblių hidraulinės dalys

Markė	Q, m ³ /val	H, m	P, kW	Pajungimas	Kaina, EUR
ST-0513-HYD (1/10)	0,3 - 1,5	78 – 23 (56)	0,37	1 1/4"	128,00
ST-0519-HYD (1/15)	0,3 - 1,5	118 – 30 (86)	0,55		155,00
ST-1010-HYD (2/9)	0,9 - 3,0	65 – 29 (55)	0,55	1 1/4"	115,00
ST-1014-HYD (2/12)	0,9 - 3,0	86 – 42 (74)	0,75		133,00
ST-1020-HYD (2/17)	0,9 - 3,0	131 – 60 (111)	1,10		160,00
ST-1028-HYD (2/23)	0,9 - 3,0	180 – 78 (138)	1,50		225,00
ST-1311-HYD	1,2 – 4,2	68 – 26 (54)	0,75		112,00
ST-1316-HYD	1,2 - 4,2	101 – 22 (77)	1,10	11/4"	148,00
ST-1814-HYD (4/12)	1,5 - 6,0	87 – 20 (68)	1,10	1 1/4"	144,00
ST-1818-HYD (4/15)	1,5 - 6,0	113 – 25 (88)	1,50		169,00
ST-1827-HYD (4/22)	1,5 - 6,0	164 – 35 (109)	2,20		228,00
ST-3514-HYD (6/13)	3,0 – 8,4	77 – 28 (59)	1,50	2"	173,00
ST-3520-HYD (6/17)	3,0 – 8,4	107 – 40 (80)	2,20		225,00
ST-4013-HYD (8/13)	4,8 – 12,0	75 – 30 (59)	2,20	2"	177,00
ST-4017-HYD (8/17)	4,8 – 12,0	98 – 46 (79)	3,00		206,00
ST-4023-HYD (8/24)	4,8 – 12,0	134 – 60 (143)	4,00		261,00
ST-5524-HYD (10/20)	4,8 – 14,4	118 – 33 (88)	4,00	2"	435,00
ST-6019-HYD (12/16)	6,0 – 16,0	102 – 37 (76)	4,00		357,00

GARANTIJA – 24 MĖNESIAI.

4" GREŽINIO SIURBLIŲ KOMPLEKTAI SU VARIKLIU „4OME-150“, Italija **(įmontuotas dažnio keitiklis maks. 1,1kW; 230V; su 30 metrų kabeliu)**

Valdiklis „Messenger“ + slėgio daviklis + išsiplėtimo bakas APT018H + bako pajungimo mazgas + hidraulika:	Hidraulikos gamintojas	Q, m³/val	H, m	Kaina, Eur su PVM
ST-0513	SISTEMA	0,3 – 1,5 (0,9)	78 – 23 (56)	1693,00
ST-0519	SISTEMA	0,3 – 1,5 (0,9)	118 – 30 (86)	1720,00
ST-1010	SISTEMA	0,9 – 3,0 (2,0)	65 – 29 (55)	1698,00
ST-1014	SISTEMA	0,9 – 3,0 (2,0)	86 – 42 (74)	1718,00
ST-1020	SISTEMA	0,9 – 3,0 (2,0)	131 – 60 (111)	1725,00
ST-1311	SISTEMA	1,2 – 4,2 (3,0)	68 – 26 (54)	1685,00
ST-1316	SISTEMA	1,2 – 4,2 (3,0)	101 – 22 (77)	1708,00
ST-1814	SISTEMA	1,5 – 6,0 (4,0)	87 – 20 (68)	1708,00
VS1/13	FRANKLIN	0,3 – 1,5 (0,9)	71 – 20 (54)	1765,00
VS2/10	FRANKLIN	1,2 – 3,3 (2,1)	60 – 20 (49)	1750,00
VS2/14	FRANKLIN	1,2 – 3,3 (2,1)	85 – 27 (68)	1770,00
VS2/20	FRANKLIN	1,2 – 3,3 (2,1)	120 – 40 (97)	1798,00
VS3/15	FRANKLIN	1,0 – 4,2 (3,0)	97 – 35 (63)	1783,00
VS4/14	FRANKLIN	1,8 – 6,0 (4,2)	80 – 26 (59)	1788,00
4SR1/10S	PEDROLLO	0,3 – 1,8 (1,2)	69,5 – 32,5 (51)	1855,00
4SR1/15S	PEDROLLO	0,3 – 1,8 (1,2)	104 – 48,5 (78)	1915,00
4SR1/20S	PEDROLLO	0,3 – 1,8 (1,2)	139 – 65 (103)	1973,00
4SR1.5/11S	PEDROLLO	0,3 – 2,7 (1,5)	78 – 26,5 (62,5)	1848,00
4SR1.5/15S	PEDROLLO	0,3 – 2,7 (1,5)	106 – 36 (84)	1898,00
4SR1.5/22S	PEDROLLO	0,3 – 2,7 (1,5)	154 – 52,5 (122)	1975,00
4SR2/9S	PEDROLLO	0,6 – 3,9 (2,4)	67 – 19,5 (49,5)	1838,00
4SR2/12S	PEDROLLO	0,6 – 3,9 (2,4)	90 – 25,5 (66)	1863,00
4SR2/17S	PEDROLLO	0,6 – 3,9 (2,4)	127 – 36,5 (94)	1915,00
4SR4/12S	PEDROLLO	1,2 – 6,0 (4,2)	91 – 33,5 (66)	1860,00

Pastaba: Darbo kreivių tolerancija atitinka EN ISO 9906 p.3B (Q ±9%, H±7%).

Stulpelyje Q ir H skliaustuose esantys skaičiai rodo slėgį prie nurodyto našumo.

Modelis	Kodas	Kaina, Eur su PVM
4OME-150 variklis su 30 metrų kabelio	07E1101233520-3	868,00
Valdiklis „Messenger“	14901	500,00
Slėgio daviklis PT-506 0 – 10 bar	VFA	93,00

GARANTIJA SIURBLIAMS – 24 MĖNESIAI.

4" PEDROLLO siurblių grežiniams hidraulinės dalys (EU 547/2012, MEI ≥ 0,40)

Markė	Q, m ³ /val	H, m	P, kW	Kaina Eur
4SR1/10HYD	0,3-1,8 (1,2)	69,5-32,5 (51)	0.37	313,00
4SR1/15-HYD	0,3-1,8 (1,2)	104-48,5 (78)	0.55	373,00
4SR1/20-HYD	0,3-1,8 (1,2)	139-65 (103)	0.75	448,00
4SR1/29-HYD	0,3-1,8 (1,2)	201-94 (150)	1.1	643,00
4SR1/39-HYD	0,3-1,8 (1,2)	271-127 (202)	1.5	830,00
4SR1.5/7S-HYD	0,3-2,7 (1,5)	50-18 (40)	0.37	276,00
4SR1.5/11S-HYD	0,3-2,7 (1,5)	78-28 (62,5)	0.55	308,00
4SR1.5/15S-HYD	0,3-2,7 (1,5)	105-37 (85)	0.75	363,00
4SR1.5/22S-HYD	0,3-2,7 (1,5)	151-46 (122)	1.1	508,00
4SR1.5/30S-HYD	0,3-2,7 (1,5)	202-63 (164)	1.5	1112,00
4SR2/6S-HYD	0,6-3,9 (2,4)	45-13 (33)	0.37	277,00
4SR2/9S-HYD	0,6-3,9 (2,4)	67-19,5 (49,5)	0.55	305,00
4SR2/12S-HYD	0,6-3,9 (2,4)	90-25,7 (66,2)	0.75	320,00
4SR2/17S-HYD	0,6-3,9 (2,4)	127-36,4 (94)	1.1	402,00
4SR2/23S-HYD	0,6-3,9 (2,4)	172-49 (127)	1.5	509,00
4SR2/33S-HYD	0,6-3,9 (2,4)	246-71 (182)	2.2	659,00
4SR4/6S-HYD	1,2-6,0 (4,2)	45,5-17 (33)	0.55	314,00
4SR4/8S-HYD	1,2-6,0 (4,2)	60,5-22,5 (44)	0.75	320,00
4SR4/12S-HYD	1,2-6,0 (4,2)	91-33,5 (66)	1.1	402,00
4SR4/15S-HYD	1,2-6,0 (4,2)	114-42 (83)	1.5	447,00
4SR4/22S-HYD	1,2-6,0 (4,2)	167-61,5 (121)	2.2	618,00
4SR4/30S-HYD	1,2-6,0 (4,2)	228--84 (165)	3.0	683,00
4SR6/4S-HYD	1,5-9,0 (6,0)	25,5-9,5 (19,8)	0.55	357,00
4SR6/6S-HYD	1,5-9,0 (6,0)	38-14,5 (29,5)	0.75	364,00
4SR6/9S-HYD	1,5-9,0 (6,0)	57-21,5 (44,5)	1.1	434,00
4SR6/13S-HYD	1,5-9,0 (6,0)	83-31,5 (64,5)	1.5	495,00
4SR6/17S-HYD	1,5-9,0 (6,0)	108-41 (84)	2.2	647,00
4SR6/24S-HYD	1,5-9,0 (6,0)	152-58 (119)	3	792,00
4SR6/32S-HYD	1,5-9,0 (6,0)	203-77 (159)	4	1015,00
4SR8/4S-HYD	2,4-12 (8,4)	26-6,5 (19,4)	0.75	347,00
4SR8/7S-HYD	2,4-12 (8,4)	46-11,5 (34)	1.1	421,00
4SR8/9S-HYD	2,4-12 (8,4)	59-15 (43,5)	1.5	444,00
4SR8/13S-HYD	2,4-12 (8,4)	85-21,5 (63)	2.2	604,00
4SR8/17S-HYD	2,4-12 (8,4)	111-28 (82)	3	713,00
4SR8/24S-HYD	2,4-12 (8,4)	151-38 (116)	4	902,00
4SR8/32S-HYD	2,4-12 (8,4)	203-51 (155)	5.5	1057,00
4SR10/5-N-HYD	3,0-15	29,5-6 (19)	0.75	297,00
4SR10/7-N-HYD	3,0-15	41-8,5 (26)	1.1	361,00
4SR10/9-N-HYD	3,0-15	53-10,5 (34)	1.5	444,00
4SR10/13-N-HYD	3,0-15	77-15,5 (50)	2.2	620,00
4SR10/18-N-HYD	3,0-15	106-21 (70)	3	745,00
4SR10/24-N-HYD	3,0-15	141-28,5 (93)	4	921,00
4SR10/32-N-HYD	3,0-15	189-38 (124)	5.5	1063,00
4SR10/43-N-HYD	3,0-15	254-51 (166)	7.5	1206,00
4SR12/5-N-HYD	3,0-18	26-6 (15,9)	0.75	342,00
4SR12/7-N-HYD	3,0-18	36,5-8,5 (22)	1.1	393,00
4SR12/9-N-HYD	3,0-18	47-11 (28)	1.5	503,00
4SR12/13-N-HYD	3,0-18	68-15,5 (41)	2.2	632,00
4SR12/18-N-HYD	3,0-18	94-21,5 (57)	3	766,00
4SR12/24-N-HYD	3,0-18	126-29 (76)	4	936,00
4SR12/32-N-HYD	3,0-18	168-38,5 (101)	5.5	1341,00
4SR12/40-N-HYD	3,0-18	210-48 (127)	7.5	1543,00
4SR15/6-N-HYD	3,0-21	31,5-6 (17)	1.1	405,00
4SR15/8-N-HYD	3,0-21	41,5-7,5 (23)	1.5	486,00
4SR15/12-N-HYD	3,0-21	62,5-11,5 (33)	2.2	599,00
4SR15/16-N-HYD	3,0-21	83-15 (44)	3	735,00
4SR15/21-N-HYD	3,0-21	110-20 (58)	4	892,00
4SR15/29-N-HYD	3,0-21	151-28 (81)	5.5	1141,00
4SR15/39-N-HYD	3,0-21	203-37,5 (109)	7.5	1470,00



Pastaba: skaičius siurblio pavadinime po raidžių SR rodo optimalų siurblio našumą m³/val.

Stulpelyje H skliaustuose esantis skaičius rodo slėgį prie optimalaus našumo.

GARANTIJA: 24 mėn

4" PEDROLLO siurblių grežiniams hidraulinės dalys



Markė	Q, m ³ /val	H, m	P, kW	Kaina Eur su PVM
4SR10/5-HYD	3,0-15	31-10 (21)	1.1	342,00
4SR10/7-HYD	3,0-15	43-15 (30)	1.5	384,00
4SR10/10-HYD	3,0-15	62-20 (42)	2.2	481,00
4SR10/15-HYD	3,0-15	92-30 (64)	3	649,00
4SR10/20-HYD	3,0-15	123-40 (85)	4	808,00
4SR10/26-HYD	3,0-15	160-52 (110)	5.5	1098,00
4SR10/35-HYD	3,0-15	216-70 (148)	7.5	1400,00
4SR12/4-HYD	3,0-18	24-8 (16)	1.1	342,00
4SR12/6-HYD	3,0-18	37-14 (28)	1.5	393,00
4SR12/9-HYD	3,0-18	55-22 (42)	2.2	503,00
4SR12/12-HYD	3,0-18	73-29 (56)	3	632,00
4SR12/16-HYD	3,0-18	97-38 (75)	4	766,00
4SR12/22-HYD	3,0-18	135-53 (103)	5.5	912,00
4SR12/29-HYD	3,0-18	176-71 (135)	7.5	1341,00
4SR15/5-HYD	3,0-22,5	30-7,5 (20)	1.5	405,00
4SR15/7-HYD	3,0-22,5	42-10 (27)	2.2	486,00
4SR15/10-HYD	3,0-22,5	60-15 (38)	3	599,00
4SR15/13-HYD	3,0-22,5	77-19 (50)	4	735,00
4SR15/18-HYD	3,0-22,5	108-27 (71)	5.5	892,00
4SR15/24-HYD	3,0-22,5	145-36 (95)	7.5	1141,00

Pastaba: skaičius siurblio pavadinime po raidžių SR rodo optimalų siurblio našumą m³/val .
Stulpelyje H skliaustuose esantis skaičius rodo slėgį prie optimalaus našumo.

GARANTIJA: hidraulikoms – 24 mėn

Aušinimo vamzdžiai su filtru 4" siurbliams

Variklio galingumas kW	Franklin		Kodas	Kaina, Eur	Pedrollo		Kodas	Kaina, Eur
	230 V	400 V			230 V	400 V		
0,37	+	+	ASSKIT4SRCR1 535 mm	250,00	+	+	ASSKIT4SRCR2 650 mm	265,00
0,55	+	+			+	+		
0,75		+			+	+		
0,75	+		ASSKIT4SRCR2 650 mm	265,00			ASSKIT4SRCR3 820 mm	279,00
1,1	+	+			+	+		
1,5	+	+			+	+		
2,2		+	ASSKIT4SRCR3 820 mm	279,00			ASSKIT4SRCR4 1000 mm	292,00
2,2	+							
3,0		+				+		
4,0		+	ASSKIT4SRCR4 1000 mm	292,00		+		
5,5		+				+		
7,5		+				+		

Aušinimo vamzdžiai 6" siurbliams

Variklio galingumas kW	Kodas	Kaina, Eur
4,0	ASSKIT6SRCR1 695 mm	613,00
5,5		
7,5		
9,2	ASSKIT6SRCR2 855 mm	645,00
11		
15		
18,5	ASSKIT6SRCR3 1205 mm	700,00
22		
30		



Komplekta sudaro:

- aušinimo vamzdis su filtru
- variklio tarpiklis
- sandarinimo tarpinė
- atramos horizontaliam montavimui 2 vnt., sąvaržos 3 vnt

4" PEDROLLO 4HR siurblių grežiniams hidraulinės dalys **iš nerūdijančio plieno AISI 304**



Markė	Q, m ³ /val	H, m	P, kW	Kaina, Eur su PVM
4HR10/5-HYD*	3,0-15,0	25,5-7 (17)	0.75	1053,00
4HR10/7-HYD*	3,0-15,0	36-10 (24)	1.1	1365,00
4HR10/10-HYD*	3,0-15,0	51,5-14 (34)	1.5	1846,00
4HR10/15-HYD*	3,0-15,0	77-21 (52)	2.2	2626,00
4HR10/20-HYD*	3,0-15,0	103-28 (68)	3	3445,00
4HR10/28-HYD*	3,0-15,0	144-39 (96)	4	4706,00
4HR14/6-HYD*	3,0-20,4	29,5-9 (20)	1.1	1248,00
4HR14/8-HYD*	3,0-20,4	39,5-12 (26,5)	1.5	1573,00
4HR14/12-HYD*	3,0-20,4	59-18 (40)	2.2	2249,00
4HR14/16-HYD*	3,0-20,4	79-23,5 (54)	3	2912,00
4HR14/21-HYD*	3,0-20,4	104-31 (70,5)	4	3736,00
4HR14/29-HYD*	3,0-20,4	143-43 (98)	5.5	5083,00
4HR18/4-HYD*	3,0-25,2	22-5 (13,5)	1.1	897,00
4HR18/6-HYD	3,0-25,2	33,5-7 (20,3)	1.5	1222,00
4HR18/9-HYD	3,0-25,2	50-11 (30,5)	2.2	1703,00
4HR18/12-HYD	3,0-25,2	66,5-14,5 (40,5)	3	2210,00
4HR18/16-HYD	3,0-25,2	89-19 (54)	4	2847,00
4HR18/22-HYD	3,0-25,2	122-26,5 (74)	5.5	3822,00
4HR18/30-HYD	3,0-25,2	167-36 (101)	7.5	4910,00



* Dėl pristatymo termino klausti papildomai.

Pastaba: skaičius siurblio pavadinime po raidžių HR rodo optimalų siurblio našumą m³/val.

Stulpelyje H skliaustuose esantis skaičius rodo slėgį prie optimalaus našumo.

GARANTIJA – 24 mėn.

6" giluminiai siurbliai 6SR su Franklin/Pedrollo varikliais

Markė 400 V	Q, m ³ /val	H, m	P, kW	Kaina Franklin, Eur su PVM	Kaina Pedrollo, Eur su PVM
6SR12/8	3.0-19.8	106-32 (80)	4	3019,00	2535,00
6SR12/11	3.0-19.8	146-44 (110)	5.5	3171,00	2683,00
6SR12/15	3.0-19.8	199-60 (150)	7.5	3487,00	2885,00
6SR12/18	3.0-19.8	239-72 (180)	9.2	3738,00	3120,00
6SR12/21	3.0-19.8	279-84 (210)	11	3955,00	3262,00
6SR12/25	3.0-19.8	331-100 (250)	13	4502,00	3732,00
6SR12/28	3.0-19.8	371-112 (280)	15	4709,00	3829,00
6SR18/4	3,0-27	53,8-22 (42)	4	2885,00	2426,00
6SR18/6	3,0-27	80,5-32 (63)	5.5	3019,00	2536,00
6SR18/9	3,0-27	121-48 (94)	7.5	3240,00	2688,00
6SR18/11	3,0-27	148-59 (115)	9.2	3470,00	2878,00
6SR18/13	3,0-27	175-70 (136)	11	3701,00	3038,00
6SR18/15	3,0-27	202-80 (157)	13	4200,00	3442,00
6SR18/18	3,0-27	242-96 (188)	15	4387,00	3539,00
6SR18/22	3,0-27	296-118 (230)	18.5	4649,00	3989,00
6SR18/26	3,0-27	350-139 (272)	22	5176,00	4621,00
6SR27/4	6,0-36	53-18 (35)	4	2759,00	2373,00
6SR27/5	6,0-36	66-22 (44)	5.5	3019,00	2426,00
6SR27/7	6,0-36	92-31 (61)	7.5	3199,00	2538,00
6SR27/8	6,0-36	106-35 (70)	9.2	3401,00	2689,00
6SR27/10	6,0-36	132-44 (87)	11	3576,00	2831,00
6SR27/12	6,0-36	159-53 (105)	13	4127,00	2941,00
6SR27/14	6,0-36	185-62 (122)	15	4200,00	3393,00
6SR27/17	6,0-36	224-75 (148)	18.5	4567,00	3788,00
6SR27/20	6,0-36	264-88 (175)	22	5047,00	4245,00
6SR27/27	6,0-36	356-119 (240)	30	6371,00	4779,00
6SR36/4	6,0-48	46-17 (28)	4	3463,00	3135,00
6SR36/5	6,0-48	58-21 (35)	5.5	3767,00	3442,00
6SR36/6	6,0-48	70-25 (42)	5.5	4091,00	3709,00
6SR36/7	6,0-48	82-29,5 (49)	7.5	4486,00	4071,00
6SR36/9	6,0-48	105-37,5 (63,5)	9.2	4702,00	4250,00
6SR36/11	6,0-48	128-46 (77)	11	5384,00	4847,00
6SR36/13	6,0-48	152-54,5 (91)	13	5593,00	5055,00
6SR36/15	6,0-48	175-63 (105)	15	6257,00	5864,00
6SR36/18	6,0-48	210-75 (127)	18.5	7087,00	6817,00
6SR36/22	6,0-48	257-92 (155)	22	7913,00	7400,00
6SR44/4	12-60	43-8 (24)	4	3348,00	3021,00
6SR44/5	12-60	53,5-10 (30)	5.5	3527,00	3201,00
6SR44/6	12-60	64-11,5 (36)	7.5	3767,00	3370,00
6SR44/8	12-60	86-15,5 (48)	9.2	4053,00	3636,00
6SR44/10	12-60	107-19,5 (60)	11	4373,00	3912,00
6SR44/12	12-60	128-23,5 (69)	13	4906,00	4379,00
6SR44/14	12-60	150-27,5 (85)	15	5127,00	4606,00
6SR44/16	12-60	171-31 (95)	18.5	5620,00	5206,00
6SR44/20	12-60	214-39 (119)	22	6303,00	6026,00
6SR44/25	12-60	267-49 (148)	30	7922,00	7140,00



Pastaba: skaičius siurblio pavadinime po raidžių SR rodo optimalų siurblio našumą m³/val.
Stulpelyje H skliaustuose esantis skaičius rodo slėgį prie optimalaus našumo.

GARANTIJA SIURBLIAMS – 24 MĖNESIAI.

6" giluminiai siurbliai 6ST su Pedrollo varikiais PD/PSR

Markė 400 V	Q, m ³ /val	H, m	P, kW	Kaina PD, Eur su PVM	Kaina PSR, Eur su PVM
6ST 17/7	3,0-24,0	75-27,5 (50)	4	2697,00	3294,00
6ST 17/10	3,0-24,0	107-39 (73)	5.5	2910,00	3459,00
6ST 17/13	3,0-24,0	139-50,5 (95)	7.5	3195,00	3795,00
6ST 17/16	3,0-24,0	170-62,5 (118)	9.2	3465,00	4095,00
6ST 17/20	3,0-24,0	213-78 (150)	11	3698,00	4530,00
6ST 17/24	3,0-24,0	256-94 (180)	13	4253,00	4845,00
6ST 17/28	3,0-24,0	298-109 (208)	15	4455,00	5348,00
6ST 17/33	3,0-24,0	352-129 (240)	18.5	5430,00	5970,00
6ST 17/40	3,0-24,0	426-156 (295)	22	6285,00	7260,00
6ST 30/4	6,0-42,0	41,5-13 (28)	4	2607,00	3204,00
6ST 30/6	6,0-42,0	62,5-19,5 (42)	5.5	2820,00	3369,00
6ST 30/8	6,0-42,0	83-25,5 (56)	7.5	3075,00	3675,00
6ST 30/10	6,0-42,0	104-32 (70)	9.2	3360,00	3990,00
6ST 30/12	6,0-42,0	125-38,5 (84)	11	3488,00	4320,00
6ST 30/15	6,0-42,0	156-48 (106)	13	4058,00	4650,00
6ST 30/18	6,0-42,0	187-58 (127)	15	4253,00	5145,00
6ST 30/22	6,0-42,0	229-71 (155)	18.5	5235,00	5775,00
6ST 30/26	6,0-42,0	270-84 (183)	22	6000,00	6975,00
6ST 46/4	6,0-66,6	52,5-13 (32)	5.5	2745,00	3294,00
6ST 46/5	6,0-66,6	65,5-16 (39)	7.5	2895,00	3495,00
6ST 46/6	6,0-66,6	79-19,5 (47)	9.2	3105,00	3735,00
6ST 46/7	6,0-66,6	92-22,5 (55)	11	3299,00	4131,00
6ST 46/8	6,0-66,6	105-26 (63)	13	3758,00	4350,00
6ST 46/10	6,0-66,6	131,32 (79)	15	3878,00	4770,00
6ST 46/12	6,0-66,6	157-38,5 (94)	18.5	4725,00	5265,00
6ST 46/14	6,0-66,6	183-45 (110)	22	5370,00	6345,00
6ST 46/16	6,0-66,6	210-51,5 (128)	22	5573,00	6548,00
6ST 46/18	6,0-66,6	236-58 (143)	26	6270,00	7245,00
6ST 46/21	6,0-66,6	275-67,5 (166)	30	6495,00	7575,00
6ST 46/24	6,0-66,6	314-77 (190)	37	7335,00	8415,00
6ST 60/2	12,0-78,0	26,5-5,5 (15)	4	2508,00	3105,00
6ST 60/3	12,0-78,0	39,5-8,5 (22)	5.5	2655,00	3204,00
6ST 60/4	12,0-78,0	53-11 (29)	7.5	2820,00	3420,00
6ST 60/5	12,0-78,0	66-14 (37)	9.2	3015,00	3645,00
6ST 60/6	12,0-78,0	79-17 (44)	11	3248,00	4080,00
6ST 60/7	12,0-78,0	93-19,5 (52)	13	3689,00	4281,00
6ST 60/8	12,0-78,0	106-22,5 (59)	15	3773,00	4665,00
6ST 60/10	12,0-78,0	132-28 (74)	18.5	4581,00	5121,00
6ST 60/12	12,0-78,0	159-33,5 (89)	22	5205,00	6180,00
6ST 60/14	12,0-78,0	185-39 (104)	26	5865,00	6840,00
6ST 60/17	12,0-78,0	225-47,5 (126)	30	6210,00	7290,00
6ST 60/20	12,0-78,0	265-56 (149)	37	7050,00	8130,00



Pastaba: skaičius siurblio pavadinime po raidžių SR rodo optimalų siurblio našumą m³/val. Stulpelyje H skliaustuose esantis skaičius rodo slėgį prie optimalaus našumo.

GARANTIJA SIURBLIAMS – 24 MĖNESIAI.

PEDROLLO 6" giluminių siurblių 6SR hidraulinės dalys

Markė 400 V	Q, m ³ /val	H, m	P, kW	Kaina Eur su PVM
6SR12/8-HYD	3,0-19,8	106-32 (80)	4	1161,00
6SR12/11-HYD	3,0-19,8	146-44 (110)	5,5	1268,00
6SR12/15-HYD	3,0-19,8	199-60 (150)	7,5	1422,00
6SR12/18-HYD	3,0-19,8	239-72 (180)	9,2	1527,00
6SR12/21-HYD	3,0-19,8	279-84 (210)	11	1614,00
6SR12/25-HYD	3,0-19,8	331-100 (250)	13	1790,00
6SR12/28-HYD	3,0-19,8	371-112 (280)	15	1865,00
6SR18/4-HYD	3,0-27	53,8-22 (42)	4	1052,00
6SR18/6-HYD	3,0-27	80,5-32 (63)	5,5	1121,00
6SR18/9-HYD	3,0-27	121-48 (94)	7,5	1225,00
6SR18/11-HYD	3,0-27	148-59 (115)	9,2	1285,00
6SR18/13-HYD	3,0-27	175-70 (136)	11	1390,00
6SR18/15-HYD	3,0-27	202-80 (157)	13	1575,00
6SR18/18-HYD	3,0-27	242-96 (188)	15	1653,00
6SR18/22-HYD	3,0-27	296-118 (230)	18,5	1699,00
6SR18/26-HYD	3,0-27	350-139 (272)	22	1902,00
6SR27/4-HYD	6,0-36	53-18 (35)	4	999,00
6SR27/5-HYD	6,0-36	66-22 (44)	5,5	1011,00
6SR27/7-HYD	6,0-36	92-31 (61)	7,5	1075,00
6SR27/8-HYD	6,0-36	106-35 (70)	9,2	1096,00
6SR27/10-HYD	6,0-36	132-44 (87)	11	1383,00
6SR27/12-HYD	6,0-36	159-53 (105)	13	1430,00
6SR27/14-HYD	6,0-36	185-62 (122)	15	1450,00
6SR27/17-HYD	6,0-36	224-75 (148)	18,5	1498,00
6SR27/20-HYD	6,0-36	264-88 (175)	22	1526,00
6SR27/27-HYD	6,0-36	356-119 (240)	30	1589,00
6SR36/4-HYD	6,0-48	46-17 (28)	4	1761,00
6SR36/5-HYD	6,0-48	58-21 (35)	5,5	2027,00
6SR36/6-HYD	6,0-48	70-25 (42)	5,5	2246,00
6SR36/7-HYD	6,0-48	82-29,5 (49)	7,5	2478,00
6SR36/9-HYD	6,0-48	105-37,5 (63,5)	9,2	2602,00
6SR36/11-HYD	6,0-48	128-46 (77)	11	2920,00
6SR36/13-HYD	6,0-48	152-54,5 (91)	13	3091,00
6SR36/15-HYD	6,0-48	175-63 (105)	15	3574,00
6SR36/18-HYD	6,0-48	210-75 (127)	18,5	4098,00
6SR36/22-HYD	6,0-48	257-92 (155)	22	4577,00
6SR44/4-HYD	12-60	43-8 (24)	4	1647,00
6SR44/5-HYD	12-60	53,5-10 (30)	5,5	1786,00
6SR44/6-HYD	12-60	64-11,5 (36)	7,5	1907,00
6SR44/8-HYD	12-60	86-15,5 (48)	9,2	2043,00
6SR44/10-HYD	12-60	107-19,5 (60)	11	2264,00
6SR44/12-HYD	12-60	128-23,5 (69)	13	2515,00
6SR44/14-HYD	12-60	150-27,5 (85)	15	2642,00
6SR44/16-HYD	12-60	171-31 (95)	18,5	2916,00
6SR44/20-HYD	12-60	214-39 (119)	22	3307,00
6SR44/25-HYD	12-60	267-49 (148)	30	3950,00



Pastaba: skaičius siurblio pavadinime po raidžių SR rodo optimalų siurblio našumą m³/val.
Stulpelyje H skliaustuose esantis skaičius rodo slėgį prie optimalaus našumo.

GARANTIJA – 24 MĖNESIAI.

PEDROLLO 6" siurblių grežiniams 6HR hidraulinės dalys



iš nerūdijančio plieno AISI 304

Markė	Q, m ³ /val	H, m	P, kW	Kaina, Eur su PVM
6HR34/3-HYD	6,0-48,0	40-19 (30)	4	1820,00
6HR34/4-HYD	6,0-48,0	53-25,5 (40)	5.5	2132,00
6HR34/5-HYD	6,0-48,0	66,5-32 (55)	7.5	2436,00
6HR34/6-HYD	6,0-48,0	80-38 (62)	9,2	2743,00
6HR34/7-HYD	6,0-48,0	93-45 (72)	11	3042,00
6HR34/8-HYD	6,0-48,0	106-51 (82)	11	3367,00
6HR34/9-HYD	6,0-48,0	120-58 (92)	13	3666,00
6HR34/11-HYD	6,0-48,0	146-70 (112)	15	4303,00
6HR34/13-HYD	6,0-48,0	173-83 (132)	18,5	4927,00
6HR34/16-HYD	6,0-48,0	213-102 (157)	22	5876,00
6HR34/19-HYD	6,0-48,0	253-122 (195)	26	6773,00
6HR34/22-HYD	6,0-48,0	293-141 (225)	30	7696,00
6HR34/27-HYD	6,0-48,0	359-173 (277)	37	9230,00
6HR44/3-HYD	12,0-60,0	38-17 (26)	5.5	1820,00
6HR44/4-HYD	12,0-60,0	51-23 (35)	7.5	2132,00
6HR44/5-HYD	12,0-60,0	63,5-29 (44)	7.5	2436,00
6HR44/6-HYD	12,0-60,0	76-35 (52)	9.2	2743,00
6HR44/7-HYD	12,0-60,0	89-40,5 (62)	11	3042,00
6HR44/9-HYD	12,0-60,0	114,5-52 (77)	13	3666,00
6HR44/10-HYD	12,0-60,0	127-58 (87)	15	3991,00
6HR44/12-HYD	12,0-60,0	152-70 (105)	18.5	4615,00
6HR44/15-HYD	12,0-60,0	191-87 (132)	22	5577,00
6HR44/18-HYD	12,0-60,0	229-104 (157)	26	6461,00
6HR44/20-HYD	12,0-60,0	254-116 (175)	30	7085,00
6HR44/25-HYD	12,0-60,0	318-145 (217)	37	8632,00
6HR54/3-HYD	18,0-72,0	34-16 (24)	5.5	1820,00
6HR54/4-HYD	18,0-72,0	45,5-21 (32)	7.5	2106,00
6HR54/5-HYD	18,0-72,0	57-26,5 (40)	9.2	2392,00
6HR54/6-HYD	18,0-72,0	68,5-31,5 (48)	11	2717,00
6HR54/8-HYD	18,0-72,0	91-42 (64)	13	3315,00
6HR54/9-HYD	18,0-72,0	103-47 (72)	15	3627,00
6HR54/11-HYD	18,0-72,0	125-58 (88)	18.5	4264,00
6HR54/13-HYD	18,0-72,0	148-68 (104)	22	4875,00
6HR54/16-HYD	18,0-72,0	182-84 (128)	26	5811,00
6HR54/18-HYD	18,0-72,0	205-95 (144)	30	6396,00
6HR54/22-HYD	18,0-72,0	251-116 (176)	37	7631,00
6HR64/3-HYD	24,0-90,0	33-15 (26)	7.5	1820,00
6HR64/4-HYD	24,0-90,0	43,5-20 (33)	9.2	2106,00
6HR64/5-HYD	24,0-90,0	54,5-25 (42)	11	2392,00
6HR64/6-HYD	24,0-90,0	65,5-30 (52)	13	2717,00
6HR64/7-HYD	24,0-90,0	76-35 (60)	15	3016,00
6HR64/8-HYD	24,0-90,0	87-40 (67)	18.5	3315,00
6HR64/10-HYD	24,0-90,0	109-50 (86)	22	3939,00
6HR64/12-HYD	24,0-90,0	131-60 (102)	26	4563,00
6HR64/14-HYD	24,0-90,0	153-70 (120)	30	5226,00
6HR64/17-HYD	24,0-90,0	186-85 (144)	37	6110,00



* Dėl pristatymo termino klausti papildomai.

Pastaba: skaičius siurblio pavadinime po raidžių HR rodo optimalų siurblio našumą m³/val. Stulpelyje H skliaustuose esantis skaičius rodo slėgį prie optimalaus našumo.

GARANTIJA: hidraulikoms – 24 mėn.

PEDROLLO 3" giluminiai siurbliai su Pedrollo varikliais



Markė 230 V	Markė 400 V	P, kW	H, m	Q, m ³ /val	Pajungimas	Kaina 230 V	Kaina 400 V
3SR1M/14	3SR1/14	0,25	57 - 16	0,3 - 1,8	1"	535,00	545,00
3SR1M/21	3SR1/21	0,37	85 - 24	0,3 - 1,8		582,00	592,00
3SR1M/31	3SR1/31	0,55	126 - 35	0,3 - 1,8		664,00	664,00
3SR1M/42	3SR1/42	0,75	170 - 47,5	0,3 - 1,8		836,00	814,00
3SR1M/62	3SR1/62	1,1	252 - 70	0,3 - 1,8		1029,00	1019,00
3SR2M/10	3SR2/10	0,25	39,5 - 11	0,6 - 2,7	1"	506,00	506,00
3SR2M/14	3SR2/14	0,37	57 - 22 (43)	0,6 - 2,7		539,00	539,00
3SR2M/21	3SR2/21	0,55	85 - 33 (62)	0,6 - 2,7		613,00	613,00
3SR2M/28	3SR2/28	0,75	114 - 44 (81)	0,6 - 2,7		740,00	733,00
3SR2M/41	3SR2/41	1,1	166 - 64 (113)	0,6 - 2,7		891,00	891,00
3SR4M/5	3SR4/5	0,25	18 - 4,5	0,9 - 5,4	1"	476,00	487,00
3SR4M/8	3SR4/8	0,37	29 - 7	0,9 - 5,4		500,00	511,00
3SR4M/12	3SR4/12	0,55	43,5 - 11	0,9 - 5,4		554,00	564,00
3SR4M/16	3SR4/16	0,75	58 - 14,5	0,9 - 5,4		645,00	655,00
3SR4M/23	3SR4/23	1,1	83 - 20,5	0,9 - 5,4		749,00	749,00
3SR5M/5	3SR5/5	0,25	14,5 - 5	0,9 - 7,2	1"	525,00	557,00
3SR5M/8	3SR5/8	0,37	23,5 - 8	0,9 - 7,2		561,00	610,00
3SR5M/11	3SR5/11	0,55	32,5 - 11	0,9 - 7,2		668,00	680,00
3SR5M/15	3SR5/15	0,75	44 - 15	0,9 - 7,2		804,00	816,00
3SR5M/23	3SR5/23	1,1	67,5 - 23	0,9 - 7,2		974,00	974,00



GARANTIJA SIURBLIAMS – 24 MĖNESIAI.

3" giluminiai vandens siurbliai CEVA (Kinija)



Modelis	Galia, kW	Slėgis, m	Našumas, m ³ /val	Pajungimai	Kaina, EUR su PVM
3" gręžinio siurblys 3VS 2/22 20 m kabeliu, pultas variklyje	0,55	90,0 - 29,0 (60)	2,7 - 0,3 (2,0)	1"	159,00
3" gręžinio siurblys 3VS 2/28 20 m kabeliu, pultas variklyje	0,75	115,0 - 38,0 (70)	2,7 - 0,03 (2,0)	1"	183,00

Stulpelyje H ir Q skliaustuose esantis skaičius rodo slėgį prie optimalaus našumo.



3" giluminiai vandens siurbliai IBO (Lenkija)



Modelis	Galia, kW	Slėgis, m	Našumas, l/min	Pajungimai	Kaina, EUR su PVM
3" gręžinio siurblys 3TI 20 Su pultu viduje ir 20 m kabeliu	0,55	0,1 - 81,0 (65)	2,9 - 0,01 (1,5)	1"	213,00
3" gręžinio siurblys 3TI 27 Su pultu viduje ir 20 m kabeliu	0,75	0,1 - 109,0 (85)	2,9 - 0,01 (1,5)	1"	249,00
3" gręžinio siurblys 3SDM 24 Su pultu viduje ir 20 m kabeliu	0,75	0,1 - 80,0 (70)	4,2 - 0,6 (1,5)	1"	263,00
3" gręžinio siurblys 3SDM 33 Su pultu viduje ir 20 m kabeliu	1,10	0,1 - 115,0 (105)	4,2 - 0,6 (1,5)	1"	304,00
3,5" gręžinio siurblys 3,5SDM 3/15 Su pultu viduje ir 20 m kabeliu	1,10	0,1 - 90,0 (78)	6,0 - 0,6 (3,0)	1 1/2"	304,00



GARANTIJA SIURBLIAMS – 24 MĖNESIAI.

PEDROLLO varikliai giluminiams siurbliams

4" Vienfaziai varikliai 230 V / 50 Hz



Markė	KW	Startinė srovė nominali srovė I_n	Nominali srovė I_n A	Įtampa, V	Sukimo moment. N	Kondensatorius μF	Svoris kg	Kaina, Eur su PVM
4PDM / 0.50	0,37	3,2	3,6	230	2000	20	6,5	278,00
4PDM / 0.75	0,55	3,2	4,7	230	2000	25	7,2	284,00
4PDM / 1	0,75	3,0	5,9	230	2000	35	8,5	289,00
4PDM / 1.5	1,1	3,1	8,3	230	2000	40	10,2	340,00
4PDM / 2	1,5	3,3	10,7	230	2000	60	11,7	423,00
4PDM / 3	2,2	3,2	15,2	230	2000	75	14,9	541,00

GARANTIJA: varikliams PEDROLLO 0,37-1,1 Kw 230 V -36 mėn, kiti – 24 mėn.

4" Trifaziai varikliai 400 V / 50 Hz

Markė	KW	Startinė srovė nominali srovė I_n	Nominali srovė I_n A	Įtampa, V	Sukimo moment. N	Kondensatorius μF	Svoris kg	Kaina, Eur su PVM
4PD / 0.50	0,37	3,2	1,8	400	2000	0,52	6,5	278,00
4PD / 0.75	0,55	4	2,0	400	2000	0,63	7,2	284,00
4PD / 1	0,75	3,8	2,5	400	2000	0,71	8,5	291,00
4PD / 1.5	1,1	4,6	3,4	400	2000	0,79	9,4	340,00
4PD / 2	1,5	3,8	4,8	400	2000	0,66	10,2	366,00
4PD / 3	2,2	6,5	6,1	400	2000	0,73	11,7	472,00
4PD / 4	3	5,6	7,1	400	3000	0,79	15,0	578,00
4PD / 5.5	4	5,4	9,8	400	5000	0,77	20,1	788,00
4PD / 7.5	5,5	5,5	13,5	400	5000	0,82	24,7	955,00
4PD / 10	7,5	5,4	17,5	400	5000	0,76	29,0	1111,00

Minimalus aušinimo srautas – 8 cm/s, Maksimali vandens temperatūra – 35°C, Įsijungimų skaičius per valandą – iki 20 vienodais intervalais,

6" Trifaziai tepalu užpildyti varikliai 400 V / 50 Hz

Markė	KW	Startinė srovė nominali srovė I_n	Nominali srovė I_n A	Įtampa, V	Sukimo moment. N	Galios faktorius $\cos\phi$	Svoris kg	Kaina, Eur su PVM
6PD / 5.5	4	5,1	9,3	400	10000	0,86	34	1374,00
6PD / 7.5	5,5	5,1	12,9	400	10000	0,84	36	1415,00
6PD / 10	7,5	4,7	17,1	400	10000	0,83	39	1463,00
6PD / 12.5	9,2	4,5	21,8	400	10000	0,77	42	1593,00
6PD / 15	11	5,2	23,8	400	10000	0,82	50	1648,00
6PD / 20	15	5,0	31,6	400	10000	0,86	57	1964,00
6PD / 25	18,5	5,9	38,5	400	10000	0,84	65	2290,00
6PD / 30	22	5,5	46,5	400	20000	0,83	87	2719,00
6PD / 40	30	5,5	63	400	20000	0,83	91	3190,00
6PD / 50	37	5,1	78	400	20000	0,83	92	3640,00

Minimalus aušinimo srautas – 16 cm/s, 30 kw - 50 cm/s, Maksimali vandens temperatūra – 35°C, Įsijungimų skaičius per valandą – iki 20

6" Trifaziai vandeniu užpildyti varikliai 400 V / 50 Hz

Markė	KW	Startinė srovė nominali srovė I_n	Nominali srovė I_n A	Įtampa, V	Sukimo moment. N	Galios faktorius $\cos\phi$	Svoris kg	Kaina, Eur su PVM
6PSR / 7.5	5,5	5,1	13	400	20000	0,85	53	1795,00
6PSR / 10	7,5	5,1	16	400	20000	0,85	58	1895,00
6PSR / 12.5	9,2	4,9	20	400	20000	0,84	62	2014,00
6PSR / 15	11	5	23	400	20000	0,85	68	2216,00
6PSR / 17,5	13	5,1	27,5	400	20000	0,85	71	2410,00
6PSR / 20	15	4,8	30	400	20000	0,86	78	2657,00
6PSR / 25	18,5	5	38	400	20000	0,85	84	2917,00
6PSR / 30	22	5,2	45	400	28000	0,86	94	3646,00
6PSR / 35	26	5,2	53	400	28000	0,85	104	4054,00
6PSR / 40	30	5,2	60,5	400	28000	0,86	122	4316,00
6PSR / 50	37	5,3	75,5	400	28000	0,86	130	4790,00

Minimalus aušinimo srautas – 8 cm/s, Maksimali vandens temperatūra – 30°C, Įsijungimų skaičius per valandą – iki 20 vienodais intervalais.

GARANTIJA varikliams – 24 mėn.

FRANKLIN ELECTRIC varikliai giluminiams siurbliams

Franklin Electric

Kodas	Aprašymas	KW	Srovė I_n A	Įtampa, V	Sukimo moment. N	Svoris kg	Kaina, Eur su PVM
-------	-----------	----	------------------	-----------	------------------------	--------------	----------------------

4" Vienfaziai dvipoliai varikliai 230V

244 755 1221	2W-0,37-230-50-W	0,37	4,1	230	3000	7,8	452,00
244 757 1221	2W-0,55-230-50-W	0,55	6,5	230	3000	8,6	483,00
244 758 1221	2W-0,75-230-50-W	0,75	7,6	230	3000	10,0	519,00
244 759 1221	2W-1,1-230-50-W	1,1	10,8	230	3000	12,3	633,00

4" Vienfaziai varikliai 230V

254 805 6700	PSC-0,37-220/230-50-W	0,37	3,1	220/230	4000	6,8	366,00
254 807 6700	PSC-0,55-220/230-50-W	0,55	4,0	220/230	4000	7,9	387,00
254 808 6700	PSC-0,75-220/230-50-W	0,75	5,5	220/230	4000	8,8	418,00
254 809 6700	PSC-1,1-220/230-50-W	1,1	7,8	220/230	4000	10,3	483,00
254 810 6700	PSC-1,5-220/230-50-W	1,5	10,0	220/230	4000	11	623,00
254 811 6700	PSC-2,2-220/230-50-W	2,2	14,0	220/230	4000	14,8	737,00

4" Trifaziai varikliai 400V

234 761 6700	3P-0,37-380/415-50-W	0,37	1,1	380/415	4000	6,1	371,00
234 762 6700	3P-0,55-380/415-50-W	0,55	1,6	380/415	4000	6,6	387,00
234 763 6700	3P-0,75-380/415-50-W	0,75	2,0	380/415	4000	7,6	418,00
234 724 6700	3P-1,1-380/415-50-W	1,1	2,8	380/415	4000	8,8	462,00
234 725 6700	3P-1,5-380/415-50-W	1,5	3,9	380/415	4000	9,8	534,00
234 726 6700	3P-2,2-380/415-50-W	2,2	5,5	380/415	4000	11,4	654,00
234 764 6700	3P-3-380/415-50-W	3	7,5	380/415	4000	13,8	783,00
234 765 3421	3P-4-380/415-50-W	4	9,9	380/415	6500	21,8	1076,00
234 728 3421	3P-5,5-380/415-50-W	5,5	12,6	380/415	6500	28,7	1254,00
234 729 3421	3P-7,5-380/415-50-W	7,5	17,1	380/415	6500	32,7	1796,00

6" Trifaziai varikliai 400V









236 610 3961	3P-4-380/415-50-W	4	9,3	380/415	15500	36,8	1685,00
236 611 3961	3P-5,5-380/415-50-W	5,5	12,5	380/415	15500	40,4	1742,00
236 612 3961	3P-7,5-380/415-50-W	7,5	16,0	380/415	15500	44,5	1836,00
236 001 3961	3P-9,3-380/415-50-W	9,3	20,7	380/415	15500	46,8	1967,00
236 613 3961	3P-11-380/415-50-W	11	23,3	380/415	15500	50,2	2069,00
236 614 3961	3P-15-380/415-50-W	15	31,3	380/415	15500	56	2418,00
236 615 3961	3P-18,5-380/415-50-W	18,5	28,5	380/415	15500	62,6	2625,00
236 616 3961	3P-22-380/415-50-W	22	45,3	380/415	15500	68,6	2953,00
236 617 3961	3P-30-380/415-50-W	30	63,5	380/415	27500	83,2	3825,00
236 618 6361	3P-37-380/415-50-W	37	79,0	380/415	45000	136	5247,00
236 619 6361	3P-45-380/415-50-W	45	95,2	380/415	45000	150	6262,00

GARANTIJA: varikliams 0,37÷1,10 kW – 24 mėn., nuo 1,5 kW ir daugiau – 12 mėn.

PEDROLLO drenažiniai ir nuotėkų siurbiai

Markė 230 V	Markė 400V	Galia, kW	Našumas l/min	Slėgis, m	Pajung. diametr.	Kaina, € 230V	Kaina, € 400V	
TOP 1	—	0,25	20-160	6-1	1 1/4"	170,00	—	
TOP 2	—	0,37	20-220	8-1	1 1/4"	176,00	—	
TOP 3	—	0,55	20-260	10-2	1 1/4"	237,00	—	
TOP 4	—	0,75	20-320	12.5-2	1 1/2"	368,00	—	
TOP 5	—	0,92	20-360	15-2.5	1 1/2"	384,00	—	
TOP 2 LA	—	0,37	20-220	8-1	1 1/4"	291,00	—	
TOP 3 LA	—	0,5	20-260	10-2	1 1/4"	325,00	—	
TOP 1 - GM	—	0,25	20-160	6-1	1 1/4"	219,00	—	
TOP 2 - GM	—	0,37	20-220	8-1	1 1/4"	228,00	—	
TOP 3 - GM	—	0,55	20-260	10-2	1 1/4"	261,00	—	
TOP 4 - GM	—	0,75	20-320	12.5-2	1 1/2"	401,00	—	
TOP 5 - GM	—	0,92	20-360	15-2.5	1 1/2"	418,00	—	
TOP 1- FLOOR	—	0,25	20-120	6-2	1 1/4"	207,00	—	
TOP 2- FLOOR	—	0,37	20-150	8-2,4	1 1/4"	213,00	—	
TOP 3- FLOOR	—	0,55	20-170	9,8-2,6	1 1/4"	249,00	—	
TOP 1- FLOOR/LA	—	0,25	20-120	6-2	1 1/4"	255,00	—	
TOP 2- FLOOR/LA	—	0,37	20-150	8-2,4	1 1/4"	262,00	—	
TOP 3- FLOORLA	—	0,55	20-170	9,8-2,6	1 1/4"	293,00	—	—
TOP 1 VORTEX	—	0,25	20-140	6,3-1,6	1 1/4"	191,00	—	
TOP 2 VORTEX	—	0,37	20-180	7,1-2	1 1/4"	194,00	—	
TOP 3 VORTEX	—	0,55	20-180	8,2-2,8	1 1/4"	227,00	—	
TOP 1 VORTEX-GM	—	0,25	20-140	6,3-1,6	1 1/4"	216,00	—	
TOP 2 VORTEX-GM	—	0,37	20-180	6,5-1,5	1 1/4"	253,00	—	
TOP 3 VORTEX-GM	—	0,55	20-180	8-2,5	1 1/4"	281,00	—	
TEX 2	—	0,37	20-220	8,3-2	1 1/4"	259,00	—	
TEX 3	—	0,55	20-240	9,8-3	1 1/4"	277,00	—	
RXM 1	RX 1	0,25	20-160	7-2	1 1/4"	277,00	298,00	
RXM 2	RX 2	0,37	20-190	9.5-2,8	1 1/4"	282,00	312,00	
RXM 3	RX 3	0,55	20-220	11,5-3,5	1 1/4"	307,00	348,00	
RXM 4	RX 4	0,75	20-270	15-4,2	1 1/2"	840,00	840,00	
RXM 5	RX 5	1,1	20-320	19.5-5	1 1/2"	878,00	878,00	
RXM 1 - GM	—	0,25	20-160	7-2	1 1/4"	308,00	—	
RXM 2 - GM	—	0,37	20-190	9.5-2,8	1 1/4"	319,00	—	
RXM 3 - GM	—	0,55	20-220	11,5-3,5	1 1/4"	357,00	—	
RXM 4 - GM	—	0,75	20-270	15-4,2	1 1/2"	890,00	—	
RXM 5 - GM	—	1,1	20-320	19.5-5	1 1/2"	926,00	—	
RXM 2/20	RX 2/20	0,37	20-180	7,5-2	1 1/4"	307,00	325,00	
RXM 3/20	RX 3/20	0,55	20-180	9,5-3	1 1/4"	332,00	363,00	
RXM 4/40	RX 4/40	0,75	20-280	11-2	1 1/2"	878,00	878,00	
RXM 5/40	RX 5/40	1,1	20-380	12,5-2	1 1/2"	913,00	913,00	
RXM 2/20 – GM	—	0,37	20-190	7,5-2	1 1/4"	325,00	—	
RXM 3/20 – GM	—	0,55	20-240	9,5-2	1 1/4"	346,00	—	
RXM 4/40 – GM	—	0,75	20-340	11-2	1 1/2"	860,00	—	
RXM 5/40 – GM	—	1,1	20-380	12,5-2	1 1/2"	896,00	—	
DM 8	D 8	0,55	25-250	12,5-3	1 1/2"	431,00	453,00	
DM 10	D 10	0,75	25-300	15,5-3	1 1/2"	450,00	462,00	
DM 20	D 20	0,75	25-250	19-8	1 1/2"	453,00	482,00	
DM 30	D 30	1,1	25-275	26-9	1 1/2"	543,00	543,00	
DCM 10	DC 10	0,75	25-300	15,5-3	1 1/2"	483,00	507,00	
DCM 20	DC 20	0,75	25-250	19-8	1 1/2"	492,00	510,00	
DCM 30	DC 30	1,1	25-275	26-9	1 1/2"	541,00	541,00	
DCM 42	DC 42	1,5	25-500	30,5-3	2"	1423,0	1284,0	
DCM 43	DC 43	2,2	25-550	35-4	2"	1539,0	1377,0	
-	DC 44	3,0	25-550	37,5-7,5	2"	-	1465,0	









PEDROLLO siurbliai nuotėkoms

Markė 230 V	Markė 400V	Galia kW	Našumas l/min	Slėgis m	Pajungimo diametras	Kaina, € 230V	Kaina, € 400V	
FAMILY	—	0,50	10-220	9,7-2	11/2"	320,00	—	
FAMILY-GM	—	0,50	10-220	9,7-2	11/2"	340,00	—	
ZXM 1B/40	—	0,50	25-350	8,5-1	11/2"	346,00	—	
ZXM 1A/40	—	0,60	25-400	10,5-1,5	11/2"	371,00	—	
ZXM 2/30	—	0,55	25-320	12,5-2	11/2"	371,00	—	
ZXM2/40	—	0,55	25-400	11-2	11/2"	380,00	—	
ZXM2/30-GM	—	0,55	25-320	12,5-2	11/2"	396,00	—	
ZXM2/40-GM	—	0,55	25-400	11-2	11/2"	403,00	—	
VXM 8/35	VX 8/35	0,55	50-350	8-1	11/2"	394,00	427,00	
VXM 10/35	VX 10/35	0,75	50-400	10-2	11/2"	429,00	459,00	
VXM 15/35	VX 15/35	1,1	50-500	13,5-2	11/2"	553,00	553,00	
VXM 20/35	VX 20/35	1,5	50-600	15-1,5	11/2"	637,00	637,00	
VXM 8/50	VX 8/50	0,55	50-450	6-1,5	2"	442,00	445,00	
VXM 10/50	VX 10/50	0,75	50-550	8,5-1,5	2"	459,00	478,00	
VXM 15/50	VX 15/50	1,1	50-650	11-2	2"	568,00	568,00	
VXM 20/50	VX 20/50	1,5	50-750	13-2,5	2"	648,00	637,00	
VXM 8/35-ST	VX 8/35-ST	0,55	50-350	8,5-1	11/2"	478,00	502,00	
VXM 10/35-ST	VX 10/35-ST	0,75	50-400	10,5-2	11/2"	483,00	502,00	
VXM 15/35-ST	VX 15/35-ST	1,1	50-500	14-2	11/2"	578,00	578,00	
VXM 20/35-ST	VX 20/35-ST	1,5	50-525	16,5-2,5	11/2"	693,00	693,00	
VXM 8/50-ST	VX 8/50-ST	0,55	50-450	7-1,5	2"	483,00	507,00	
VXM10/50-ST	VX10/50-ST	0,75	50-550	9,5-1,5	2"	502,00	516,00	
VXM 15/50-ST	VX 15/50-ST	1,1	50-650	13-2	2"	589,00	589,00	
VXM 20/50-ST	VX 20/50-ST	1,5	50-700	14,5-3	2"	707,00	707,00	
BCM 10/50-ST	BC 10/50-ST	0,75	50-600	11-2	2"	567,00	585,00	
BCM 15/50-ST	BC 15/50-ST	1,1	50-750	14-2	2"	639,00	639,00	
BCM 20/50-ST	BC 20/50-ST	1,5	50-850	16-3	2"	753,00	753,00	
VXM 8/35-MF	VX 8/35-MF	0,55	50-350	8-1	11/2"	759,00	778,00	
VXM 10/35-MF	VX 10/35-MF	0,75	50-400	10-2	11/2"	768,00	791,00	
VXM 15/35-MF	VX 15/35-MF	1,1	50-500	13,5-2	11/2"	868,00	868,00	
VXM 20/35-MF	VX 20/35-MF	1,5	50-600	15-1,5	11/2"	990,00	990,00	
VXM 8/50-MF	VX 8/50-MF	0,55	50-450	6-1,5	2"	775,00	794,00	
VXM10/50-MF	VX10/50-MF	0,75	50-550	8,5-1,5	2"	784,00	802,00	
VXM 15/50-MF	VX 15/50-MF	1,1	50-650	11-2	2"	868,00	868,00	
VXM 20/50-MF	VX 20/50-MF	1,5	50-750	13-2,5	2"	1006,00	1006,00	
BCM 10/50-MF	BC 10/50-MF	0,75	50-600	11-2	2"	845,00	863,00	
BCM 15/50-MF	BC 15/50-MF	1,1	50-750	14-2	2"	929,00	929,00	
BCM 20/50-MF	BC 20/50-MF	1,5	50-850	16-3	2"	1025,00	1025,00	
VXCM 10/35	VXC 10/35	0,75	50-400	10-2	11/2"	536,00	553,00	
VXCM 15/35	VXC 15/35	1,1	50-500	13,5-2	11/2"	617,00	617,00	
VXCM 10/45	VXC 10/45	0,75	50-550	8,5-1,5	2"	536,00	560,00	
VXCM 15/45	VXC 15/45	1,1	50-650	11-2	2"	617,00	617,00	
MCM 10/45	MC 10/45	0,75	50-600	11-2	2"	567,00	591,00	
MCM 15/45	MC 15/45	1,1	50-750	14-2	2"	651,00	651,00	
BCM 10/50	BC 10/50	0,75	50-600	11-2	2"	506,00	517,00	
BCM 15/50	BC 15/50	1,1	50-750	14-2	2"	584,00	584,00	
BCM 20/50	BC 20/50	1,5	50-850	16-3	2"	707,00	707,00	

GARANTIJA siurbliams – 24 mėn.

PEDROLLO siurbliai nuotėkoms



Markė 230 V	Markė 400V	Galia kW	Našumas l/min	Slėgis m	Pajungimo diametras	Kaina, € 230V	Kaina, € 400V	
VXCM 15/50	VXC 15/50	1,1	100-600	11-2	2 1/2"	1164,00	1157,00	
VXCM 20/50	VXC 20/50	1,5	100-700	12,5-2,5	2 1/2"	1221,00	1192,00	
VXCM 30/50	VXC 30/50	2,2	100-850	15,5-2,5	2 1/2"	2001,00	1228,00	
-	VXC 40/50	3,0	100-1050	19-2	2 1/2"	-	1411,00	
VXCM 15/65	VXC 15/65	1,1	200-850	7-1	3"	1215,00	1252,00	
VXCM 20/65	VXC 20/65	1,5	200-1000	8,5-1	3"	1303,00	1280,00	
VXCM 30/65	VXC 30/65	2,2	20-1200	11,1-1,5	3"	2096,00	1318,00	
-	VXC40/65	3,0	20-1250	15-2	3"	-	1462,00	
VXCM 15/50-F	VXC 15/50-F	1,1	100-600	11-2	2 1/2"	1225,00	1225,00	
VXCM 20/50-F	VXC 20/50-F	1,5	100-700	12,5-2,5	2 1/2"	1288,00	1261,00	
VXCM 30/50-F	VXC 30/50-F	2,2	100-850	15,5-2,5	2 1/2"	2055,00	1293,00	
-	VXC 40/50-F	3,0	100-1050	19-2	2 1/2"	-	1411,00	
VXCM 15/65-F	VXC 15/65-F	1,1	200-850	7-1	3"	1337,00	1317,00	
VXCM 20/65-F	VXC 20/65-F	1,5	200-1000	8,5-1	3"	1385,00	1370,00	
VXCM 30/65-F	VXC 30/65-F	2,2	20-1200	11,1-1,5	3"	2162,00	1406,00	
-	VXC40/65-F	3,0	20-1250	15-2	3"	-	1523,00	
MCM 15/50	MC 15/50	1.1	100-800	14-1	2 1/2"	1231,00	1208,00	
MCM 20/50	MC 20/50	1.5	100-900	16-1	2 1/2"	1298,00	1234,00	
MCM 30/50	MC 30/50	2.2	100-1100	22-2	2 1/2"	1906,00	1339,00	
-	MC 40/50	3.0	100-1100	24-4	2 1/2"	-	1633,00	
MCM 30/65	MC 30/65	2.2	200-1500	12-2	3"	1933,00	1432,00	
-	MC 40/65	3.0	200-1600	15-4	3"	-	1679,00	
MCM 15/50-F	MC 15/50-F	1,1	100-800	14-1	2 1/2"	1294,00	1277,00	
MCM 20/50-F	MC 20/50-F	1.5	100-900	16-1	2 1/2"	1360,00	1298,00	
MCM 30/50-F	MC 30/50-F	2.2	100-1100	22-2	2 1/2"	1975,00	1396,00	
-	MC 40/50-F	3.0	100-1100	24-4	2 1/2"	-	1684,00	
MCM 30/65-F	MC 30/65-F	2.2	200-1500	12-2	3"	1969,00	1483,00	
-	MC 40/65-F	3.0	200-1600	15-4	3"	-	1746,00	
-	VX40/50	3.0	100-900	22-5,5	DN50/2"	-	1893,00	
-	VX55/50	4.0	100-1000	25-6,5	DN50/2"	-	2075,00	
-	VX40/65	3.0	200-1200	15,6-2,5	DN65/2,5"	-	2075,00	
-	VX55/65	4.0	200-1350	19,4-3.7	DN65/2,5"	-	2220,00	
-	VX75/65	5.5	200-1500	23,6-5.5	DN65/2,5"	-	2312,00	
-	VX40/80	3.0	200-1200	11,5-3	DN80/3"	-	2118,00	
-	VX55/80	4.0	200-1400	16-4	DN80/3"	-	2287,00	
-	VX75/80	5.5	200-1800	21-4,5	DN80/3"	-	2375,00	
-	BC40/35	3.0	300-1500	18,5-5,5	DN65/2,5"	-	2123,00	
-	BC55/35	4.0	300-1700	22,5-7,5	DN65/2,5"	-	2242,00	
-	BC75/35	5.5	300-1900	27,5-10	DN65/2,5"	-	2350,00	
-	BC40/50	3.0	300-1800	16-4,5	DN80/3"	-	2143,00	
-	BC55/50	4.0	300-2100	20-6	DN80/3"	-	2303,00	
-	BC75/50	5.5	300-2300	24,5-7,5	DN80/3"	-	2387,00	
-	VXC4 40/100	3.0	300-1700	7,6-2	DN100	-	3873,00	
-	VXC4 50/100	3.7	300-2000	10,2-2,7	DN100	-	3945,00	
-	VXC4 55/100	4.0	300-2200	11,7-3	DN100	-	4023,00	
-	VXC4 100/80	7.5	800-3300	13-4	DN100	-	9903,00	
-	VXC4 125/80	9.2	800-3800	14,9-4	DN100	-	10022,00	
-	VXC4 150/80	11	800-4200	17,3-4	DN100	-	10150,00	
-	VXC4 200/80	15	800-5000	20,1-4	DN100	-	10280,00	
-	MC4 40/55	3.0	400-2400	10-3,6	DN80	-	3968,00	
-	MC4 50/55	3.7	400-2700	12,6-4,8	DN80	-	4027,00	
-	MC4 55/55	4.0	400-2900	14-5,3	DN80	-	4086,00	
-	MC4 90/80	6.7	800-4200	15,4-4	DN100	-	9903,00	
-	MC4 110/80	8.0	800-4600	17,7-4,5	DN100	-	10022,00	
-	MC4 125/80	9.2	800-5000	19,7-5	DN100	-	10140,00	

* - VXCM – MCM/50-65 vienfaziai 1.1-2.2 kW siurbliai komplektuojami su paleidimo pultu, įskaičiuota į kainą

Montavimo komplektai siurbliams VX/35-ST/MF, VX/50-ST/MF, BC/50-ST/MF

Kodas	Aprašymas	Charakteristika	Kaina, €	
ASSPVX35ST	Montavimo komplektas su horizontaliu išėjimu siurbliams VX /35-ST-MF	2"	114,00	
ASSPVX50ST	Montavimo komplektas su horizontaliu išėjimu siurbliams VX /50-ST-MF, BC /50-ST-MF	2"	116,00	
ASSPVX35STV	Montavimo kompl. su vert. išėjimu VX /35-ST-MF	21/2"	205,00	
ASSPVX50STV	Montavimo kompl. su vert. išėjimu VX /50-ST-MF, BC /50-ST-MF	21/2"	219,00	
859SV340INTFA	Tarpinis kreipiančiųjų laikiklis Ø3/4" montuojamas kas 2m		25,00	
54SARTG0052F	Kreipiančioji AISI 304 Ø3/4" 2m ilgio	Vnt.	100,00	
54SARTG0053F	Kreipiančioji AISI 304 Ø3/4" 3m ilgio	Vnt.	136,00	
54SARTG0056F	Kreipiančioji AISI 304 Ø3/4" 6m ilgio	Vnt.	242,00	





Montavimo komplektai fekaliniams siurbliams VXC/-F, VX, BC, BC/-F

Kodas	Aprašymas	Charakteristika	Kaina, €	
ASSVXCF051	Hor. mont. kompl. Ø3/4" siurbliams VXC/50-F, MC/50-F	2"	148,00	
ASSVXCF051V	Vert. mont. Komplektas Ø3/4" VXC/50-F, MC/50-F	21/2"	249,00	
ASSVXCF071V	Vert. mont. komplektas Ø3/4" VXC/65-F, MC/65-F	3"	381,00	
ASSVXCF07040V	Vert. mont. kompl. Ø2" VXC/50-F, MV/50-F	3"	760,00	
ASSVXCF07050V	Vert. mont. kompl. Ø2" VXC/65-F, MV/65-F	3"	855,00	
ASSPVX50	Horiz. mont. komplektas siurbliams Ø3/4" VX/50	2"	155,00	
ASSPVX503V	Vert. mont. komplektas siurbliams Ø3/4" VX/50	21/2"	276,00	
ASSPVX653V	Vert. mont. komplektas siurbliams Ø3/4" VX/65, BC/35	3"	361,00	
ASSVXCF071V	Vert. mont. komplektas siurbliams Ø3/4" BC/50	3"	381,00	
ASSPVX50V	Vert. mont. komplektas siurbliams Ø2" VX/50	3"	747,00	
ASSPVX65V	Vert. mont. komplektas siurbliams Ø2" VX/65, BC/35	3"	767,00	
ASSVXCF0705V	Vert. mont. komplektas siurbliams Ø2" VX/80, BC/50	3"	855,00	
ASSPVXC4V	Vert. mont. komplektas siurbliams Ø2" VXC4, MC4/80	4"	870,00	
ASSPMC4V	Vert. mont. komplektas siurbliams Ø2" MC4/55	3"	844,00	
859SV340INTFA	Tarpinis laikiklis kreipiančiosiems Ø3/4" mont. kas 2 m.	vnt.	25,00	
859SV349INTFA	Tarpinis laikiklis kreipiančiosiems Ø2" mont. kas 3 m.	vnt.	109,00	
54SARTG0052F	Kreipiantysis vamzdis AISI304 Ø3/4", ilgis 2 m	vnt	100,00	
54SARTG0053F	Kreipiantysis vamzdis AISI304 Ø3/4", ilgis 3 m	vnt	136,00	
54SARTG0056F	Kreipiantysis vamzdis AISI304 Ø3/4", ilgis 6 m	vnt	242,00	
54SARTG0063F	Kreipiantysis vamzdis AISI304 Ø2", ilgis 3 m	vnt	242,00	
54SARTG0066F	Kreipiantysis vamzdis AISI304 Ø2", ilgis 6 m	vnt	448,00	



GARANTIJA SIURBLIAMS – 24 MĖNESIAI.

PEDROLLO siurbliai su smulkintuvu TRITUS



Markė 230 V	Markė 400V	Galia kW	Našumas l/min	Slėgis m	Pajungimas	Kaina, € 230V	Kaina, € 400V	
TRITUS-TX	-	0,55	10-90	11,5-1,0	1 1/4"	470,00	-	
TRITUS INOX TIGm 0.55	-	0,55	20-130	14,5-2	1 1/2"	770,00	-	
TRITUS INOX TIGm 0.75	-	0,75	20-140	17,5-2	1 1/2"	793,00	-	
TRITUS INOX TIGm 1.1	-	1,1	20-140	22,5-6,8	1 1/2"	972,00	-	
TRITUS INOX TIGm 1.3	-	1,3	20-240	20,5-7	1 1/2"	996,00	-	
TRITUS TRM0.75	TRITUS TR0.75	0,75	10-120	15,7-4	1 1/4"	1015,00	929,00	
TRITUS TRM0.9	TRITUS TR0.9	0,9	10-140	15,5-6	1 1/4"	1037,00	952,00	
TRITUS TRM1.1	TRITUS TR1.1	1,1	10-125	22-9,5	1 1/4"	1088,00	988,00	
TRITUS TRM1.3	TRITUS TR1.3	1,3	10-200	23-6,2	1 1/4"	1110,00	1012,00	
TRITUS TRM1.5	TRITUS TR1.5	1,5	10-240	25,5-8	DN40/ 1 1/2"	1813,00	1605,00	
-	TRITUS TR2.2	2,2	20-280	30-2	DN40/ 1 1/2"	-	1718,00	
TRITUS TRM2.2AP	TRITUS TR2.2AP	2,2	10-270	35-11	DN40/ 1 1/2"	2351,00	1813,00	
-	TRITUS TR3AP	3,0	20-300	42,5-11	DN40/ 1 1/2"	-	1927,00	
-	TRITUS TR3	3,0	20-350	33,5-14,2	DN40/ 1 1/2"	-	2029,00	
-	TRITUS TR4	4,0	20-350	39,5-19,4	DN40/ 1 1/2"	-	2245,00	

Montavimo komplektai siurbliams TRITUS

Kodas	Aprašymas	Charakteristika	Kaina, €	
ASSPTRITUS11	Montavimo komplektas su horizontaliu išėjimu siurbliams TR0.75 - TR1.3	2"	129,00	
ASSPTRITUS22	Montavimo komplektas su horizontaliu išėjimu siurbliams TR1.5 - TR2.2	2"	129,00	
ASSPTRITUS61	Montavimo kompl. su horizontaliu išėjimu TR2.2 AP-TR3 AP, TR3, TR4	2"	152,00	
ASSPTRITUS11V	Montavimo kompl. su vert. išėjimu TR0.75 - TR1.3	2"	222,00	
ASSPTRITUS22V	Montavimo kompl. su vert. išėjimu TR1.5 - TR2.2	2 1/2"	222,00	
ASSPTRITUS61V	Montavimo kompl. su vert. išėjimu TR2.2AP-TR3AP, TR3, TR4	2 1/2"	247,00	
859SV340INTFA	Tarpinis laikiklis kreipiančiosioms Ø3/4"	vnt.	25,00	
54SARTG0052F	Kreipiantysis vamzdis AISI304 Ø3/4", ilgis 2 m	vnt	100,00	
54SARTG0053F	Kreipiantysis vamzdis AISI304 Ø3/4", ilgis 3 m	vnt	136,00	
54SARTG0056F	Kreipiantysis vamzdis AISI304 Ø3/4", ilgis 6 m	vnt	242,00	

GARANTIJA SIURBLIAMS – 24 MĖNESIAI.

Nuotėkų mini siurblinės

Modelis	Galia kW	Našumas l/min	Slėgis m	Išmatavimai mm	Prijungiami prietaisai	Kaina, €
IBO SANIBO 5	0,60	0 - 150	9,5 - 1	240x290x440	WC, praustuvas arba dušas, bide	274,00
CEVA F600A	0,60	0 - 160	9,5 - 1	240x285x440	WC, praustuvas arba dušas, bide	187,00



GARANTIJA – 24 MĖNESIAI

Nuotėkų siurblinės PEDROLLO



Modelis	Talpa l	Galia kW	Našumas maks l/min	Slėgis maks m	Išmatavimai PxGxA, mm	Kaina, €
SAR40-RXM1-GM	40	0,25	160	6,5	410x370x410	659,00
SAR100-VXM10/35	100	0,75	400	10	690x500x645	1160,00
SAR100-TIGM0.75	100	0,75	140	17,5	690x500x645	1530,00
SAR100-TIGM1.1	100	1,1	150	22,5	690x500x645	1784,00
SAR100-TIGM1.3	100	1,3	250	20,5	690x500x645	1844,00
SAR250-VXM15/35	250	1,1	450	14	725x880x880	1740,00
SAR250-VXM15/50	250	1,1	650	11	725x880x880	1777,00
SAR250-TIGM1.1	250	1,1	150	22,5	725x880x880	2338,00
SAR250-TIGM1.3	250	1,3	250	20,5	725x880x880	2400,00
SAR550-VXM15/50	550	2x1,1	2x500	10,5	1475x880x880	4160,00
SAR550-TRM1.1	550	2x1,1	2x140	21,5	1475x880x880	5020,00
SAR550-TRM1.3	550	2x1,3	2x250	22,5	1475x880x880	5090,00
SAR550-TRM1.5	550	2x1,5	2x270	25	1475x880x880	6515,00

GARANTIJA SIURBLIAMS – 24 MĖNESIAI, TALPOMS – 10 METŲ.

KSKIT-308MA	Paukštinimas 300 mm SAR250-550 montavimui giliau po žeme	200,00
KSKIT-ALLARME	Signalizacijos komplektas komplektą įeina: plūdinis jungiklis, autonominė sirena, pultas	560,00

SAR40

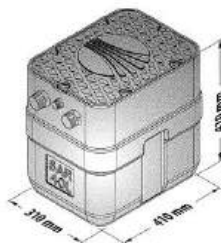

SAR100

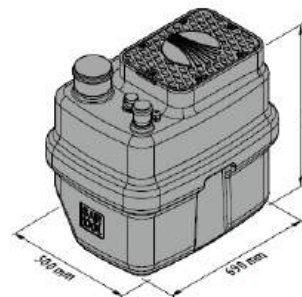

SAR250

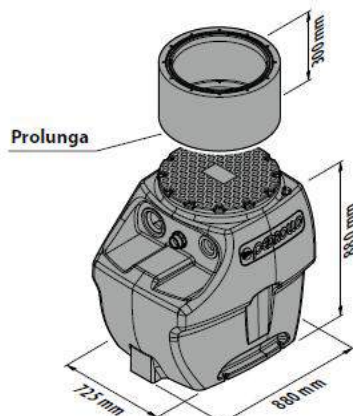

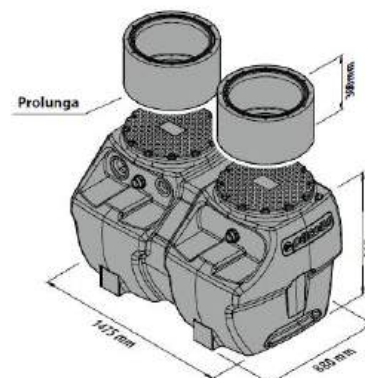

SAR550











Vandens siurbliai CEVA

Modelis	Galia, kW	Slėgis, m	Našumas, l/min	Pajungimai	Kaina, EUR su PVM	
CJET 100B	0,75	43,0 – 5,0	10,0 – 52,0	1"	86,00	
CJETS 100B	0,75	43,0 – 5,0	10,0 – 52,0	1"	92,00	

Automatinės vandens tiekimo sistemos CEVA

Modelis	Hidroforo talpa, l	Įsiurbimo gylis, m	Galia, kW	Slėgis, m	Našumas, l/min	Pajungimai	Kaina, EUR su PVM	
CJET100B-24L	24	8	0,75	43,0 – 5,0	10,0 – 52,0	1"	125,00	
CJETS100B-24L	24	8	0,75	43,0 – 5,0	10,0 – 52,0	1"	133,00	
CJET100B-24APT*	24	8	0,75	43,0 – 5,0	10,0 – 52,0	1"	167,00	
CJETS100B-24APT*	24	8	0,75	43,0 – 5,0	10,0 – 52,0	1"	175,00	

Vandens siurbliai su slėgio palaikymo automatinė sistema VOLYFORD **VOLYFORD**



Modelis	Įsiurbimo gylis, m	Galia, kW	Slėgis, m	Našumas, m ³ /val.	Pajungimai	Kaina, EUR su PVM	
VLF-T68	6	0,68	55,0 – (28,0) – 0,1	0,01 – (3,0) – 5,5	1"	460,00	
VLF-T88	8	0,88	60,0 – (33,0) – 0,1	0,01 – (3,0) – 5,8	1"	510,00	

VLF-T serijos siurbliai yra kelių pakopų išcentriniai nuolatinio magneto siurbliai su dažnio keitikliu. Siurblių hidraulinė dalis yra pagamintas iš nerūdijančio plieno, atsparūs rūgštims ir šarmams bei atsparūs korozijai, o tai gali užkirsti kelią rūdžių susidarymui ir padeda sveikai naudoti vandenį. Sumanus nuolatinis vandens tiekimas gali efektyviai taupyti energiją ir elektrą bei patenkinti skirtingus klientų poreikius naudoti vandenį.

SIURBLIAMS GARANTIJA – 24 mėnesiai. * Hidroforams – 60 mėnesių.



Drenažiniai vandens siurbliai CEVA

Modelis	Galia, kW	Slėgis, m	Našumas, l/min	Pajungimai	Kaina, EUR su PVM	
VPB 400	0,40	0,1 – 5,0	125,0 – 0,01	1" – 1½"	49,00	
VGW 900	0,90	0,1 – 9,0	250,0 – 0,01	1" – 1½"	78,00	

Nuotėkų siurbliai CEVA

Modelis	Galia, kW	Slėgis, m	Našumas, l/min	Pajungimai	Kaina, EUR su PVM	
VVD1100F (su smulkintuvu)	1,10	3,0 – 10,0	270,0 – 0,01	2"	209,00	

3" giluminiai vandens siurbliai gręžiniams CEVA

Modelis	Pastaba	Galia, kW	Slėgis H, m	Našumas Q, m³/val	Pajungimai	Kaina, EUR su PVM	
3VS 2/22	Su įmontuotu variklyje paleidimo pultu ir 20 m kabeliu	0,55	90,0 – 20,0 (52)	0,4 – 2,76 (2,0)	1"	159,00	
3VS 2/28	Su įmontuotu variklyje paleidimo pultu ir 20 m kabeliu	0,75	115,0 – 25,0 (65)	0,4 – 2,76 (2,0)	1"	183,00	

Stulpelyje H ir Q skliaustuose esantis skaičius rodo slėgį prie optimalaus našumo.

Vibraciniai siurbliai CEVA

Modelis	Galia, kW	Slėgis, m	Našumas, l/min	Pajungimai	Kaina, EUR su PVM	
VS280 Su 10m kabelio	0,25	79 – 1	0,1 – 16	1/2"	36,00	















Nuotėkų mini siurblinės

Modelis	Galia, kW	Našumas, l/min	Slėgis, m	Išmatavimai, mm	Prijungiami prietaisai	Kaina, €
CEVA F600A	0,60	0 - 160	9,5 - 1	240x285x440	WC, praustuvas arba dušas, bide	187,00



SIURBLIAMS GARANTIJA – 24 MĖNESIAI.







Vandens siurbliai IBO (Lenkija)

Modelis	Galia, kW	Slėgis, m	Našumas, m ³ /val	Pajungimai	Kaina, EUR su PVM	
JET100A	1,10	0,1 – 49,0	3,54 – 0,1	1"	105,00	
AJ50/60	1,10	0,1 – 49,0	3,54 – 0,1	1"	114,00	
JET100A-24L Hidroforo talpa – 24l Pasiurbimo gylis – 8 m	1,10	0,1 – 49,0	3,54 – 0,1	1"	172,00	
JET100A-24APT Hidroforo talpa – 24l Pasiurbimo gylis – 8 m	1,10	0,1 – 49,0	3,54 – 0,1	1"	237,00	
AJ50/60-24L Hidroforo talpa – 24l Pasiurbimo gylis – 8 m	1,10	0,1 – 49,0	3,54 – 0,1	1"	194,00	
Siurblys šuliniui OLA60/60 INOX Su plūde ir 18 m kabeliu	0,80	0,1 – 71,0	3,54 – 0,1	1"	268,00	
3" gręžinio siurblys 3TI 20 Su pultu viduje ir 20 m kabeliu	0,55	0,1 – 81,0 (65)	2,9 – 0,4 (1,5)	1"	213,00	
3" gręžinio siurblys 3TI 27 Su pultu viduje ir 20 m kabeliu	0,75	0,1 – 109,0 (85)	2,9 – 0,4 (1,5)	1"	249,00	
3" gręžinio siurblys 3SDm 24 Su pultu viduje ir 20 m kabeliu	0,75	0,1 – 80,0 (70)	4,2 – 0,6 (1,5)	1"	263,00	
3" gręžinio siurblys 3SDm 33 Su pultu viduje ir 20 m kabeliu	1,10	0,1 – 115,0 (105)	4,2 – 0,6 (1,5)	1"	304,00	
4" gręžinio siurblys 4SKM100 Su pultu viduje ir 14 m kabeliu	0,75	0,1 – 59,0 (42)	2,0 – 0,01 (0,9)	1"	194,00	
4" gręžinio siurblys 4SDm 2/12 Su pultu viduje ir 20 m kabeliu	0,75	0,1 – 84,0 (72)	4,7 – 0,01 (1,8)	1¼"	260,00	
4" gręžinio siurblys 4SDm 3/14 Su pultu viduje ir 1,5 m kabeliu	1,10	0,1 – 102,0 (85)	5,6 – 0,01 (2,7)	1¼"	306,00	
Panardinamas siurblys RAINER 1200 AUTO Su automatika ir 10 m kabeliu	1,2	0,1 - 48	5,7 – 1,0	1"	299,00	

GARANTIJA – 24 MĖNESIAI

Vandens siurbliai IBO (Lenkija)



Modelis	Galia, kW	Slėgis, m	Našumas, m ³ /val	Pajungimai	Kaina, EUR su PVM	
Drenažinis siurblys IP550	0,55	0,1 – 6,9	10,4 – 0,1	1" – 1½"	66,00	
Drenažinis siurblys IP900 INOX	0,90	0,1 – 8,0	14 – 0,1	1" – 1½"	107,00	
Drenažinis siurblys su integruota pludė IPC550	0,55	0,1 – 5,8	6,0 – 0,1	1¼"	125,00	
Nuotėkų siurblys WQF750	0,75	0,1 – 12,0	23,4 – 0,1	2"	174,00	
Nuotėkų siurblys WQF1100	1,10	0,1 – 13,0	27,0 – 0,1	2"	191,00	
Nuotėkų siurblys su smulkintuvu F1100	1,10	0,1 – 15,0	18,0 – 0,1	2"	256,00	

Nuotėkų siurblinė IBO







Modelis	Galia, kW	Slėgis, m	Našumas, m ³ /val	Pajungiami prietaisai	Kaina, EUR su PVM	
SANIBO 5	0,60	9,5 – 1	0 – 9,0	WC, praustuvas arba dušas, bide	274,00	

Rankinis siurblys

Modelis	Įsiurbimo gylis, m	Našumas, l/min	Siurblio / stovo aukštis, mm	Įsiurbimo vamzdis	Kaina, EUR	
Rankinis siurblys ABYSSINIAN su stovu	7,0	28,0	680 /670	1¼"	196,00	

GARANTIJA – 24 MĖNESIAI

Paleidimo ir apsaugos pultai siurbliams

Modelis	P, kW	U, V	I, A	C, μ F	Kaina, Eur	
COV-BOX M 75	0,55	230	6	25	48,00	
QEM 050	0,37	230	5	20	79,00	
QEM 075	0,55	230	6	25	79,00	
QEM 100	0,75	230	7	35	81,00	
QEM 150	1,1	230	11	40	88,00	
QEM 200	1,5	230	13	60	88,00	
QEM 300	2,2	230	18	75	97,00	
SubStart SS 037SC	0,37	230	3,3	16	81,00	
SubStart SS 055SC	0,55	230	4,3	20	81,00	
SubStart SS 075SC	0,75	230	5,7	35	84,00	
SubStart SS 110SC	1,1	230	8,4	40	86,00	
SubStart SS 150SC	1,5	230	10,7	50	94,00	
KAVP-1-4 1,1-1,5kw	1,1-1,5	400	2,4-4,0	-	249,00	
KAVP-1-4 1,5-3,0kw	2,2-3,0	400	4,0-6,0	-	249,00	
QET 050	0,37	400	1,7	-	214,00	
QET 075	0,55	400	2	-	214,00	
QET 100	0,75	400	2,5	-	227,00	
QET 150	1,1	400	3,9	-	227,00	
QET 200	1,5	400	4,8	-	232,00	
QET 300	2,2	400	7	-	236,00	
QET 400	3	400	9	-	263,00	
QET 550	4	400	11,5	-	270,00	
QET 750	5,5	400	15,5	-	282,00	
QET 1000	7,5	400	21,5	-	396,00	
QET 1250	9,2	400	23,5	-	415,00	
QET 1500	11	400	27,5	-	556,00	
QET 2000	15	400	36	-	836,00	
QET 2500	18,5	400	45	-	966,00	
QET 3000	22	400	54	-	966,00	
QET 4000	30	400	68	-	1265,00	
E1 MONO	0,37-2,2	230	Iki 18 A	-	314,00	
E1 TRI/1	0,55-7,5	400	Iki 18 A	-	435,00	
E1 TRI/2	7,5-11	400	Iki 25 A	-	457,00	
SUBMONITOR Franklin Electric	2,2-150	190-600	3-359	-	685,00	

Paleidimo ir apsaugos pultai nuotėkų siurbliams

QES 300 MONO	2,2	230	16	60	295,00	
QES 150	1,1	400	4,2	-	255,00	
QES 200	1,5	400	5,2	-	260,00	
QES 300	2,2	400	6,5	-	265,00	
QES 400	3,0	400	8,0	-	270,00	
E2 MONO	0,37-2,2	230	2-18	-	390,00	
E2 TRI	0,55-3,7	400	2-16	-	538,00	



Dažnio keitiklis „WHITE“ (PM Technology®, PEDROLLO Group), Italija

Intuityvus ir lengvai naudojamas įrenginys. Komplekte slėgio daviklis VLF-506 (0 – 16 bar).

Lankstumas: naudodami "Bluetooth®" sąsają ir "PM MyConnect" programėlę galite išplėsti naudojimo galimybes ir nustatyti maždaug 50 parametrų, kad pritaikytumėte sistemą prie jos poreikių.



Supaprastinta pagalbos procedūra: su "PM MyConnect" programėle galite nusiųsti dabartinę keitiklio konfigūraciją "PM" technikams, kad jie galėtų išanalizuoti problemas arba tiesiog atlikti konkrečiai sistemai skirtus pataisymus.

Modelis	P, kW	I _{max} , A	U ₁ , V	U ₂ , V	IP	Kaina, Eur su PVM	
WHITE S 102	iki 1.5	iki 11	1x230 ±15%	1x230 ±15%	55	570,00	

GARANTIJA – 24 MĖNESIAI.

Dažnio keitikliai DG Flow® (PEDROLLO), Italija



Modelis	P, kW	I _{max} , A	U ₁ , V	U ₂ , V	IP	Kaina, Eur su PVM	
Vandeniu aušinami dažnio keitikliai							
STEADYPRES TT 6E 1"	iki 2.2	iki 6	3x400	3x400	65	1030,00	
STEADYPRES TT 8E	iki 3.0	iki 8	±10%	±10%		1089,00	
Su slėgio davikliu, skirtas atskiriems elektriniams siurbliams ir siurblių grupėms iki 3 vnt.							
DGFIT MM 8-S	iki 1.1	iki 8.5	1x230 ±10%	1x230 ±10%	54	748,00	
DGFIT MM 11-S	iki 1.5	iki 11				786,00	
DGFIT MM 16-S	iki 2.2	iki 16				820,00	
DGFIT TT 6E-S	iki 2.2	iki 6	3x400	3x400	54	1584,00	
DGFIT TT 8E-S	iki 3.0	iki 8	±10%	±10%	1639,00		



GARANTIJA – 24 MĖNESIAI.

Elektros tinklų filtrai DG Flow® (PEDROLLO), Italija

Modelis	Maksimali įtampa, V (AC)	Talpa, μF	Nominalinė srovė I _n , A	Maksimali srovė, A	IP	Kaina, Eur su PVM	
Sinusoidinis išėjimo filtras tarp variklio ir dažnio keitiklio, kada kabelio ilgis ne mažiau 20 m							
SF M 09	250	-	9	5% I _n	65	372,00	
SF M 16	250	-	16	5% I _n	65	693,00	
SF T 08	432	0.73	8	10% I _n	64	935,00	
SF T 12	432	1.1	12	10% I _n	64	1144,00	
SF T 16	432	1.1	16	10% I _n	64	1221,00	
SF T 20	432	1.5	20	10% I _n	64	1721,00	

GARANTIJA – 24 MĖNESIAI.

Dažnio keitikliai VOLYFORD (WASINEX), Kinija**VOLYFORD**

Modelis	P, kW	I _{max} , A	U ₁ , V	U ₂ , V	IP	Kaina, Eur su PVM	
VFA-10M 0.75kW	iki 0,75	iki 4,8	1x220 -20%÷+15%	1x220	55	244,00	
VFA-10M 1.1kW	iki 1,1	iki 7				277,00	
VFA-10M 1.5kW	iki 1,5	iki 9,6				286,00	
VFA-10M 2.2kW	iki 2,2	iki 11,5				308,00	
VFA-10T 1.1kW	iki 1,1	iki 3,2	3x380- 20%÷+15%	3x380	55	252,00	
VFA-10T 1.5kW	iki 1,5	iki 4,3				268,00	
VFA-10T 2.2kW	iki 2,2	iki 5				293,00	
VFA-10LT 4.0kW	iki 3,0	iki 9,3				502,00	
VFA-18M 0,75kW	iki 0,75	iki 4,8	1x220 -20%÷+15%	1x220	55	229,00	
VFA-18M 1,1kW	iki 1,1	iki 7				262,00	
VFA-18M 1,5kW	iki 1,5	iki 9,6				271,00	
VFA-18M 2,2kW	iki 2,2	iki 11,5				293,00	
Vandeniui aušinami dažnio keitikliai, pajungimai 1¼"							
VFA-60M 0,75kW	iki 0,75	iki 4,8	1x220 -20%÷+15%	1x220	55	229,00	
VFA-60M 1,1kW	iki 1,1	iki 7				262,00	
VFA-60M 1,5kW	iki 1,5	iki 9,6				271,00	
VFA-60M 2,2kW	iki 2,2	iki 11,5				293,00	

GARANTIJA – 24 MĖNESIAI.**Slėgio davikliai VOLYFORD (WASINEX), Kinija**

Modelis	Slėgis, bar	Išėjimas, mA	Įtampa, V (DC)	Paklaida, % FC (-10,+90°C)	IP	Kaina, Eur su PVM	
PT- 506	0 ÷ 10	4 ÷ 20	8 ÷ 28	maks. ±0,5	67	93,00	
VLF-506	0 ÷ 16	4 ÷ 20	8 ÷ 28	maks. ±0,5	67	93,00	

Dažnio keitikliai ELECTROIL, Italija



Modelis	P, kW	I _{max} , A	U ₁ , V	U ₂ , V	IP	Kaina, Eur su PVM	
IMMP1.1W IMMP1.5W	iki 1.1 iki 1.5	iki 9 iki 11	1x230 ±10%	1x230 ±10%	65	459,00 573,00	
IMMP1.5W-BC IMMP1.8W-BC	iki 1.5 iki 1.8	iki 11 iki 13	1x230 ±10%	1x230 ±10%	65	654,00 705,00	
ITTP1.5W-BC ITTP1.5W-BC LCD	iki 1.5	iki 4	3x(200-400)	3x(200-400)	65	735,00 837,00	
ITTP2.2W-BC ITTP3.0W-BC	iki 2.2 iki 3.0	iki 5.5 iki 7.5	3x(200-400)	3x(200-400)	55	930,00 1000,00	
ITTP4.0W-RS ITTP5.5W-RS ITTP7.5W-RS	iki 4.0 iki 5.5 iki 7.5	iki 10 iki 14 iki 18	3x(200-400)	3x(200-400)	55	1575,00 1681,00 1989,00	
ITTP11W-RS/BC ITTP15W-RS/BC	iki 11.0 iki 15.0	iki 23 iki 33	3x(200-400)	3x(200-400)	55	2455,00 2927,00	
ITTP22W-RS/BC ITTP30W-RS/BC	iki 22.0 iki 30.0	iki 46 iki 58	3x(200-400)	3x(200-400)	54	3663,00 4072,00	

Pastabos: BC(BlueConnect) – grupinis pajungimas per „Bluetooth“; RS – grupinis pajungimas per magistralę RS485; I_{max} - maksimali elektros srovė keitiklio išėjime; U₁ – elektros tinklo įtampa; U₂ – elektros įtampa keitiklio išėjime. Slėgio daviklis K16 (firmos Keller, Šveicarija) įeina į dažnio keitiklio kainą. **GARANTIJA – 24 MĖNESIAI.**



Slėgio davikliai Keller, Šveicarija

Modelis	Slėgis, bar	Išėjimas, mA	Įtampa, V (DC)	Paklaida, % FC (-10,+90°C)	IP	Kaina, Eur su PVM	
K16	0 ÷ 16					128,00	
HS16 (išardomas)	0 ÷ 16	4 ÷ 20	8 ÷ 28	maks. ±1,5	67	142,00	
K25	0 ÷ 25					186,00	

Žaibų ir viršįtampių apsauga ELECTROIL, Italija

Modelis	Įtampa, V (AC)	Energija, J	Pikinė srovė, kA	Nuotėkio srovė, mA	IP	Kaina, Eur su PVM	
LPM275V470J LPT550V940J	275 550	470 940	22 (8/20 μs)	<2	65	83,00 112,00	

Elektros tinklų filtrai ELECTROIL, Italija

Modelis	Maksimali įtampa, V (AC)	Talpa, μF	Nominalinė srovė I _n , A	Maksimali srovė, A	Svoris, kg	Kaina, Eur su PVM	
Sinusoidinis išėjimo filtras tarp variklio ir dažnio keitiklio, kada kabelio ilgis ne mažiau 20 m.							
EF8260112001 EF8280008001	250 460	- 0,73	12 8	5% I _n 10% I _n	1,75 3,20	299,00 548,00	
Papildomas EMS triukšmus mažinantis jėgimo filtras tarp įvado ir dažnio keitiklio, kai kabelio ilgis ne mažiau 20 m.							
EF825004 EF825005 EF825006 EF825007 EF825008	250 250 520 520 520	- - - - -	10 20 5 10 20	5% I _n 5% I _n 10% I _n 10% I _n 10% I _n	0,16 0,25 1,60 1,60 1,80	83,00 122,00 251,00 324,00 430,00	

Aksesuarai ir atsarginės dalys siurbliams, hidroforams

Pavadinimas	Tipas	Charakteristika	Kaina, €	
Slėgio relė ITALTECNICA	PM/5 L	250 V, 1-5 bar, 16A, vid.sriegis ¼", IP 44, dif.min-0,6, dif.max -2,3	15,50	
	PM/5ML	250 V, 1-5 bar, 16A, iš.sriegis ¼", IP 44, dif.min-0,6, dif.max -2,3	15,50	
	PM /12L	250 V, 3-12 bar, 16A, vid.sriegis ¼", IP 44, dif.min-1,5, dif.max -5	18,00	
	PT/12L	500 V, 3-12 bar 16A, vid.sriegis ¼", IP 44, dif.min-1,5, dif.max -5	18,00	
Slėgio relė TELEMECANIQUE	SREL XMP	250 V, 1-6 bar, 16A, vid.sriegis ¼", IP 65, dif.min-0,6	40,00	
Slėgio relė su apsauga nuo sausos eigos SCHNEIDER ELECTRIC	FSG2J SQUARE D	250 V, 1-5 bar, 16A, vid.sriegis ¼", IP 44, dif.min-0,6, dif.max -2,5, sausos eigos atjungimas žemiau 0,5 bar	39,00	
Apsauga nuo sausos eigos ITALTECNICA	LP/3	250 V, 16A, 0,1-0,5 bar, įsijungimo slėgio ribos 0,5-0,9 bar	17,00	
Skaitmeninė slėgio relė EVAK <i>Atspari drėgmei, apsaugo siurbliū nuo sauso darbo, lengvai programuojama, nustatymai išlieka dingus elektrai.</i>	DPC-10	110-230 V, 12A, 0,1-10 bar, IP55	79,00	
	DPC-10A	110-230 V, 12A, 0,1-10 bar, IP55 su Schuko šakute	89,00	
Elektroniniai siurblių darbo kontrolės įtaisai	BRIO 2000M	230V, 0,9 KW, 12A, 1" Reg. įsijungimo slėgis – 1-3,5 bar IP65, Tmax - 55°C	71,00	
	PRESFLO VARIO	230V, 16A, Q _{max} - 200 l/min, 1" Įsijungimo slėgis – 1,5 bar, išėjimo slėgis (reguliuojamas 0,8- 2,4 bar) IP65, Tmax - 65°C	99,00	
	PRESFLO MULTI	230V, 4-16A, Q _{max} - 200 l/min, 1" Reg. įsijungimo slėgis – 2 bar (reg. 1-5 bar) IP65, Tmax - 65°C, siurblio apsauga nuo perkrovos ir nuo dažno junginėjimosi dėl pratekėjimo sistemoje.	199,00	
	EP	110-230V (+/-10%), 10A, 5-45°C, Siurblio apsauga nuo sausos eigos, per žemos / per aukštos įtampos, per aukštos srovės	90,00	
Plūdinė relė ITALTECNICA	IGTP5	Laidas H07RN-F 3x1 , ilgis 5m, universalai (pripildymui / ištuštinimui) IP68, Tmax - 60°C, 10 (8) A, 250V	19,00	
Antivibracinė žarna 1"	TFG 5	500 mm su alkūne	14,00	
	TFG 6	600 mm su alkūne	14,50	
	TF 6	600 mm tiesi	13,90	
	TF 10	1000 mm tiesi	19,50	
Manometras ¼"	MR 6	6 bar	5,20	
	MR 10	10 bar	5,20	
Vandens skaitiklis ROSSWEINER	SKS12 SKK12 SKS34 SKK34	Q _n =1,5m ³ /h, L=185mm, ½", šaltam v. Q _n =1,5m ³ /h, L=185mm, 1/2", karštam v. Q _n =2,5 m ³ /h, L=230mm, 3/4", šaltam v. Q _n =2,5 m ³ /h, L=230mm, 3/4", karštam v.	27,90 27,90 39,00 39,00	

Pavadinimas	Tipas	Charakteristika	Kaina, €	
Trišakė jungtis Penkiašakė jungtis	R 3 R 5	1" 1"x1/4"	8,00 9,00	
Atbulinis vožtuvas Pedrollo / Tiemme	VR0.5 VR0.75 / VR075E VR1 / VR1E VR1.25 / VR1.25E VR1.5 / VR1.5E VR2 / VR2E	1/2" 3/4" 1" 1 1/4" 1 1/2" 2"	7,60 / - 10,90 / 12,0 13,20 / 22,0 21,00 / 36,0 25,50 / 46,0 45,00 / 73,0	
Rutulinis atbulinis vožtuvas nuotėkoms	VR-FT32 VR-FT40 VR-FT50	1 1/4" 1 1/2" 2"	69,00 85,00 98,00	
Gręžinio dangtis Gręžinio dangtis Hermetinė galvutė guminė Hermetizacija Gręžinio dangtis	A1645 A1630 HERMI DG125145 GD125/32	DN 125-140 DN 140x1" DN 125/140 DN 125/140 DN 125x1"	81,00 83,00 110,00 22,00 54,00	
Adapteris	ADAP25NEW A1650 EMS ADAP32 ADAP40 ADAP50	1"- nereikalingas praplatinimas 1"- nereikalingas praplatinimas 1 1/4" 1 1/2" 2"	54,00 71,00 79,00 260,00 350,00	
Nerūdyjančio plieno trosas	LLL LLL4 LLL5	DN 3 mm DN 4 mm DN 5 mm	0,90 1,45 1,75	
Nerūdyjančio plieno užspaudėjai	LL3 LL4 LL5	DN 3 mm DN 4 mm DN 5 mm	1,30 1,40 2,00	
Hermetinė kabelio sujungimo mova	GPS1-3M GPS1-3PETRI GPS1-PETRI	4x2,5 mm ²	28,00 20,00 15,00	
Kabelis giluminių siurblių montavimui	K02 K04 K06 K08 K10	H07RN-F 4x1,5 H07RN-F 3x2,5 H07RN-F 4x2,5 CYKY 4x2,5 CYKY 4x4	2,70 3,40 4,10 2,80 3,80	
Kondensatorius		10-25 mF 45-55 mF	6,00 9,00	
Membrana hidroforui VAREM, ZILMET	MEMBUT MEMBUT50 MEMBUT6080 MEMBUT100 MEMBUT200 MEMBUT300 MEMBUT500	20-24 l, Ø80-90 mm 50-60 l 60-80 l 100 l 200 l 300 l 500 l	12,50 45,00 45,00 77,00 160,00 230,00 410,00	

Hidroforai MAXIVAREM (Italija)



Membraniniai hidroforai šalto vandens sistemoms, atitinka ES direktyvą 97/23/CE. Butilo membrana atitinka DIN 4807-3, tinka geriamo vandens sistemoms. Oro slėgis - 2 bar. Darbinė temperatūra: (-10°C - +99°C). **Garantija – 12 mėn.**

Pavadinimas	Talpa, l	Maks. slėgis bar	Pajungimas	Išmatavimai Ø x L, mm	Kaina, Eur su PVM	
LS H 20	20	10	1"	274x497	49,00	
LS H 50	50	10	1"	410x610	130,00	
LS H 60	60	10	1"	410x670	169,00	
LS H 80	80	10	1"	479x637	210,00	
LS H 100	100	10	1"	485x756	265,00	
LS V 100	100	10	1"	450x910	259,00	
LS V 200	200	10	1 1/2"	554x1250	449,00	
LS V 300	300	10	1 1/2"	624x1370	595,00	
LS V 500	500	10	1 1/2"	775x1460	999,00	

CEVA YH24L	24	8	1"	265x440	33,00	
CEVA YHS24L ner.pl	24	8	1"	265x440	69,00	
CEVA 100LV	100	8	1"	460x760	130,00	

Hidroforai su fiksuota diafragma AQUASKY PLUS (Taivanas)

Diafragminiai išsiplėtimo indai šalto geriamo vandens sistemoms. CE sertifikatas, ISO9001 kokybės sistema. **Maksimali darbinė temperatūra: +93°C, Maks. darbinis slėgis – 10 bar. Garantija – 5 metai.**



Pavadinimas	Talpa, l	Oro slėgis, bar	Pajungimas	Išmatavimai Ø x L, mm	Kaina, Eur su PVM	
APT001,3	1,3	2,0	1/2"	120x201	25,00	
APT003	3	2,0	1"	140x220	28,00	
APT008	8	2,0	1"	203x304	41,00	
APT012	12	2,0	1"	229x384	47,00	
APT018H	18	2,0	1"	280x390	58,00	
APT024H	24	2,0	1"	290x415	66,00	
APT024V	24	2,0	1"	290x415	66,00	
APT040H	40	2,0	1"	295x550	130,00	
APT060H	60	2,0	1"	381x530	160,00	
APT060V	60	2,0	1"	381x600	157,00	
APT080H	80	2,0	1"	381x730	202,00	
APT080V	80	2,0	1"	381x780	198,00	
APT100H	100	2,0	1"	430x690	243,00	
APT100V	100	2,0	1"	430x765	252,00	
APT160V	160	2,0	1 1/4"	550x915	438,00	
APT200V	200	2,0	1 1/4"	550x1060	515,00	
APT240V	240	2,0	1 1/4"	559x1160	619,00	
APT300V	300	2,0	1 1/4"	559x1450	753,00	
APT450V	450	2,0	1 1/4"	650x1400	965,00	

Hidroforai GLOBAL WATER SOLUTIONS (JAV)











Diafragminiai išsiplėtimo indai šalto geriamo vandens sistemoms. CE sertifikatas, ISO9001 kokybės sistema. **Maksimali darbinė temperatūra - +90°C. Garantija – 5 metai.**



Pavadinimas	Talpa, l	Maks. slėgis bar	Oro slėgis bar	Išmatavimai Ø x L, mm	Kaina, Eur su PVM	
PWB 24 H	24	10	2,5	317x444	88,00	
PWB 60 H	60	10	1,9	414x528	210,00	
PWB 60V	60	10	1,9	388x626	205,00	
PWB 80 H	80	10	1,9	414x724	246,00	
PWB 80V	80	10	1,9	388x790	243,00	
PWB 100V	100	10	1,9	430x800	309,00	
PWB 150V	150	10	1,9	430x1070	465,00	





Elektriniai vandens šildytuvai ATLANTIC



Markė	Tūris l	Matmenys AxPxG, mm	Galia, kW	Sušildymo laikas iki 60°C (Δ50°C)	Nuostoliai kWh/paraž prie 65°C	ErP	Kaina Eur su PVM	
PCRB10 (Art. 821179)/ PCSB10 (Art.821180) O'PRO* pakabinamas vertikalus	10	456x255x262	1.6/2.0	24 min./19 min.	0.48/0.63	A/B	123,00	  
PC15RB (Art. 821181)/ PS15SB (Art. 821182) O'PRO* pakabinamas vertikalus	15	400x338x347	1.6/2.0	35 min./28 min.	0.58/0.66	B/B	137,00	
PC30 SLIM O'PRO (Art. 831042) pakabinamas vertikalus	30	617x338x347	2.0	57 min.	0.76	C	152,00	
NANTO SWH010A (Art.821491)/ NANTO SWH010U (Art.821492)** pakabinamas vertikalus	10	387x360x262	2.0	18 min./18 min.	0.48	A/B	137,00	
NANTO SWH015A (Art.821494)/ NANTO SWH015U (Art.821498)** pakabinamas vertikalus	15	387x360x321	2.0	27 min./27 min.	0.58	A/B	148,00	
NANTO SWH030A (Art.831226)** pakabinamas vertikalus	30	467x440x388	2.0	53 min.	0.84	C	159,00	
ATL050 CLASSIC O'PRO (Art. 841324) pakabinamas vertikalus	50	612x433x451	1.5	2 val. 4 min.	0.95	C	168,00	
ATL080 CLASSIC O'PRO (Art. 851344) pakabinamas vertikalus	80	859x433x451	1.5	3 val. 28 min.	1.40	C	186,00	
ATL100 CLASSIC O'PRO (Art. 861343) pakabinamas vertikalus	100	1021x433x451	1.5	4 val. 11 min.	1.85	C	201,00	
VM050 EXPERT O'PRO (Art. 841350) pakabinamas vertikalus	50	629x433x451	2.0	1 val. 25 min.	0.95	C	172,00	
VM080 EXPERT O'PRO (Art. 851396) pakabinamas vertikalus	80	876x433x451	2.0	2 val. 34 min.	1.35	C	202,00	
VM100 EXPERT O'PRO (Art. 861366) pakabinamas vertikalus	100	1038x433x451	2.0	3 val. 05 min.	1.70	C	217,00	
HM080 CLASSIC O'PRO (Art. 853071) pakabinamas horizontalus	75	433x843x451	1.5	2 val. 53 min.	1.55	C	194,00	
HM100 CLASSIC O'PRO (Art. 863077) pakabinamas horizontalus	100	433x1005x451	1.5	3 val. 58 min.	1.93	C	216,00	
HM080 O'PRO+ (Art. 853081) pakabinamas horizontalus	75	433x843x451	1.5	2 val. 53 min.	1.55	C	201,00	
HM100 O'PRO+ (Art. 863086) pakabinamas horizontalus	100	433x1005x451	1.5	3 val. 58 min.	1.93	C	223,00	 
CE150L HM ATE (Art. 873211) pakabinamas horizontalus	150	1155x505x530	2.2	5 val. 29 min.	1.75	C	488,00	
CE200L HM ATE (Art. 883062) pakabinamas horizontalus	200	1475x505x530	2.2	5 val. 33 min.	2.07	C	531,00	
ATL150 WM O'PRO+ (Art. 871236) pakabinamas vertikalus	150	1210x513x530	2.2	4 val. 14 min.	1.65	C	394,00	

Elektriniai vandens šildytuvai ATLANTIC









Markė	Tūris l	Matmenys AxPxG, mm	Galia, kW	Sušildymo laikas iki 60°C (Δ50°C)	Nuostoliai kWh/parą prie 65°C	ErP	Kaina Eur su PVM	
ATL200 WM O'PRO+ (Art. 881222) pakabinamas <u>vertikalus</u>	200	1475x513x530	2.2	5 val. 44 min.	1.94	C	462,00	
CE200 FS 2200M (Art. 882157) <u>pastatomas</u>	200	1270x575x590	2.2	5 val. 06 min.	1.82	C	565,00	
CE300 FS 2200M (Art. 892299) <u>pastatomas</u>	300	1765x570x640	3.0	5 val. 53 min.	2.41	C	1007,00	
IMMENSIO VS 500L (Art. 022826) <u>pastatomas vertikalus</u>	500	1840x750x850	5.0	5 val. 53 min.	2.60	C	2439,00	
ATLANTIC 500L (Austria Email) (Art. 022750) <u>pastatomas</u>	500	1840x750x850	5.0	5 val. 53 min.	2.60	C	2439,00	

* RB – virš plautuvės; SB – po plautuve.

** SWHXXXA – virš plautuvės; SWHXXXU – po plautuve.

GARANTIJA TALPAI: 5 metai. GARANTIJA ELEKTRINĖMS DALIMS: 2 metai.

Elektriniai vandens šildytuvai ATLANTIC su su uždaru kaitinimo elementu

Markė	Tūris l	Matmenys AxPxG, mm	Galia kW	Sušildymo laikas iki 60°C (Δ50°C)	Nuostoliai kWh/parą prie 65°C	ErP	Kaina, Eur su PVM	STEATITE TECHNOLOGY
VM050 STEATITE TURBO (Art. 841351) pakabinamas <u>vertikalus</u>	50	629x433x451	2.1	1 val. 19 min.	0.95	C	267,00	
VM080 STEATITE TURBO (Art. 851397) pakabinamas <u>vertikalus</u>	80	876x433x451	2.1	2 val. 22 min.	1.35	C	290,00	
VM0100 STEATITE TURBO (Art. 861367) pakabinamas <u>vertikalus</u>	100	1038x433x451	2.1	3 val. 09 min.	1.70	C	310,00	
ATL150 WM STEATITE (Art. 871235) pakabinamas <u>vertikalus</u>	150	1220x505x520	1.8	5 val. 16 min.	1.59	C	434,00	
ATL200 WM STEATITE (Art. 881221) pakabinamas <u>vertikalus</u>	200	1550x505x525	2.4	5 val. 20 min.	1.94	C	491,00	
CE200 SS STEATITE (Art. 882156) <u>pastatomas 230/380V</u>	200	1275x575x600	3,0	4 val. 45 min.	1,95	C	609,00	
CE300 VS STEATITE (Art. 892250) <u>pastatomas 230/380V</u>	300	1780x575x640	3,0	6 val. 6 min.	2,5	C	1219,00	

GARANTIJA TALPAI: 5 metai. GARANTIJA ELEKTRINĖMS DALIMS: 2 metai.

Elektriniai vandens šildytuvai ATLANTIC CUBE



su uždaru kaitinimo elementu



Markė	Tūris, l	Matmenys AxPxG, mm	Maks. galia, kW	WI-FI	Sušildymo laikas iki 60°C (Δ50°C)	Nuostoliai kWh/parą prie 65°C	ErP	Kaina, Eur su PVM	STEATITE TECHNOLOGY
ATL030L VM STEATITE CUBE S3 ACCESS (Art. 831184) <i>pakabinamas vertikalus</i>	30	624x342x387	1,5	-	1 val. 16 min.	0.63	B	279,00	  
ATL050L VM STEATITE CUBE S3 ACCESS (Art. 841286) <i>pakabinamas vertikalus</i>	50	909x342x387	1,5	-	2 val. 7 min.	0.86	C	320,00	
ATL075L VM STEATITE CUBE S4 ACCESS (Art. 851267) <i>pakabinamas vertikalus</i>	75	720x490x532	1,5	-	3 val. 12 min.	0.91	C	374,00	
ATL100L VM STEATITE CUBE S4 ACCESS (Art. 861312) <i>pakabinamas vertikalus</i>	100	890x490x532	1,5	-	4 val. 14 min.	1.08	C	408,00	
ATL150L VM STEATITE CUBE S4 ACCESS (Art. 871221) <i>pakabinamas vertikalus</i>	150	1210x490x532	1,5	-	6 val. 24 min.	1.56	C	467,00	
STEATITE CUBE WI-FI WM 075L WHITE (Art. 851339) <i>pakabinamas vertikalus</i>	75	712x490x516	2,4	+	1 val. 55 min.	0.89	B	478,00	  
STEATITE CUBE WI-FI WM 100L WHITE (Art. 861339) <i>pakabinamas vertikalus</i>	100	883x490x516	2,4	+	2 val. 28 min.	1.10	B	546,00	
STEATITE CUBE WI-FI WM 150L WHITE (Art. 871232) <i>pakabinamas vertikalus</i>	150	1203x490x516	2,4	+	3 val. 40 min.	1.48	B	595,00	
STEATITE CUBE WI-FI WM 075L SILVER (Art. 851340) <i>pakabinamas vertikalus</i>	75	712x490x516	2,4	+	1 val. 55 min.	0.89	B	496,00	  
STEATITE CUBE WI-FI WM 100L SILVER (Art. 861340) <i>pakabinamas vertikalus</i>	100	883x490x516	2,4	+	2 val. 28 min.	1.10	B	558,00	
STEATITE CUBE WI-FI WM 150L SILVER (Art. 871233) <i>pakabinamas vertikalus</i>	150	1203x490x516	2,4	+	3 val. 40 min.	1.48	B	611,00	

GARANTIJA TALPAI: 5 metai. GARANTIJA ELEKTRINĖMS DALIMS: 2 metai.

Elektriniai vandens šildytuvai ATLANTIC VERTIGO

su uždarais kaitinimo elementais









Markė	Tūris, l	Matmenys AxPxG, mm	Maks. galia, kW	Wi-Fi	Bendras sušildymo laikas iki 60°C (Δ50°C)	Išeinančio bako sušildymo laikas	ErP	Kaina, Eur su PVM	STEATITE TECHNOLOGY
VERTIGO ESSENTIAL 30 (Art. 821577) <u>vertikalus/horizontalus</u>	25	594x490x290	1.0	-	1 val. 32 min.	46 min.	C	443,00	
VERTIGO ESSENTIAL 50 (Art. 831277) <u>vertikalus/horizontalus</u>	40	765x490x290	1.5	-	2 val. 2 min.	49 min.	C	471,00	
VERTIGO ESSENTIAL 80 (Art. 841396) <u>vertikalus/horizontalus</u>	65	1090x490x290	1.5	-	3 val. 19 min.	1 val. 19 min.	C	517,00	
VERTIGO ESSENTIAL 100 (Art. 851444) <u>vertikalus/ horizontalus</u>	80	1300x490x290	1.5	-	4 val. 4 min.	1 val. 38 min.	C	543,00	
VERTIGO STEATITE Wi-Fi 30 WHITE (Art. 821488) <u>vertikalus/ horizontalus, sumanus, Wi-Fi</u>	25	593x490x290	1.0	+	1 val. 27 min.	46 min.	B	483,00	
VERTIGO STEATITE Wi-Fi 50 WHITE (Art. 831216) <u>vertikalus/ horizontalus, sumanus, Wi-Fi</u>	40	766x490x290	2.25	+	2 val. 2 min.	49 min.	B	512,00	
VERTIGO STEATITE Wi-Fi 80 WHITE (Art. 841318) <u>vertikalus/ horizontalus, sumanus, Wi-Fi</u>	65	1090x490x290	2.25	+	3 val. 19 min.	1 val. 19 min.	B	557,00	
VERTIGO STEATITE Wi-Fi 100 WHITE (Art. 851337) <u>vertikalus/ horizontalus, sumanus, Wi-Fi</u>	80	1301x490x290	2.25	+	4 val. 4 min.	1 val. 38 min.	B	596,00	
VERTIGO STEATITE Wi-Fi 30 SILVER (Art. 821489) <u>vertikalus/ horizontalus, sumanus, Wi-Fi</u>	25	593x490x290	1.0	+	1 val. 27 min.	46 min.	B	494,00	
VERTIGO STEATITE Wi-Fi 50 SILVER (Art. 831217) <u>vertikalus/ horizontalus, boost, sumanus, Wi-Fi</u>	40	766x490x290	2.25	+	2 val. 2 min.	49 min.	B	532,00	
VERTIGO STEATITE Wi-Fi 80 SILVER (Art. 841321) <u>vertikalus/ horizontalus, boost, sumanus, Wi-Fi</u>	65	1090x490x290	2.25	+	3 val. 19 min.	1 val. 19 min.	B	567,00	
VERTIGO STEATITE Wi-Fi 100 SILVER (Art. 851338) <u>vertikalus/ horizontalus, boost, sumanus, Wi-Fi</u>	80	1301x490x290	2.25	+	4 val. 4 min.	1 val. 38 min.	B	605,00	

GARANTIJA BAKUI IR KAITINIMO ELEMENTUI: 5 metai. GARANTIJA KITOMS DALIMS : 2 metai.

Kombinuoti vandens šildytuvai ATLANTIC



Modelis	Tūris, l	Kaitinimo elemento galia, kW	Šilumo- kaičio plotas/galia m ² / kW**	Našumas l/val*	Nuostoliai kWh/parą prie 65°C	Matmenys (AxPxG), mm	ErP	Kaina, Eur su PVM	
CWH080 MIXTE O'PRO (Art. 854019) <i>vertikalus</i> dešinės pusės	80	1.5	0,35 / 17,5	431	1.63	791x433x 451	C	292,00	
CWH100MIXTE O'PRO (Art. 864026) <i>vertikalus</i> dešinės pusės	100	1.5	0,35 / 17,5	431	2.02	948x433x 451	C	308,00	
DUOTHERM 100L (DNE2) (Art. 874033) <i>universalus</i> , be elektrinio šildymo elemento	100	-	0,6 / 18,0	444	1.32	747x567x 579	C	471,00	
DUOTHERM 150L (DE2) (Art. 874036) <i>universalus</i> , su elektriniu šildymo elementu	150	2.20	0,95 / 26,0	642	1.64	1002x567x 579	C	723,00	
DUOTHERM 200L (DE2) (Art. 874037) <i>universalus</i> , su elektriniu šildymo elementu	200	2.20	1,2 / 29,0	708	2.16	1257x567x 579	C	750,00	
STEATITE COMBI WH 100L (Art. 864047) <i>vertikalus</i> , su elektriniu šildymo elementu 230/400V	100	 2.4	0.53 / 19,3	476	0.86	906x520x 575	B/C	650,00	
STEATITE COMBI WH 150L (Art. 874050) <i>vertikalus</i> , su elektriniu šildymo elementu 230/400V	150	 2.4	0.66 / 25,6	630	1.05	1160x520x 575	B/C	683,00	
STEATITE COMBI WH 200L (Art. 884038) <i>vertikalus</i> , su elektriniu šildymo elementu 230/400V	200	 2.4	0.66 / 25,6	630	1.30	1568x520x 575	B/C	810,00	
STEATITE SS BE 200L ATL (Art. 884035)** <i>pastatomas</i> , be elektrinio šildymo elemento	200	-	0.66 / 43,2	630	1.31	1245x635x 690	B	887,00	
STEATITE SS BE 300L ATL (Art. 896223)** <i>pastatomas</i> , be elektrinio šildymo elemento	300	-	0.66 / 49,0	630	1.64	1740x635x 690	B	1077,00	

*Prie parametrų: 90/10/45°C (šilumnešio temperatūra/jeinančio vandens temperatūra/išeinančio vandens temperatūra), našumas per šilumokaitį – 2,0 m³/val.

**Elektrinio kaitinimo elemento komplektas į šildytuvo kainą neįeina ir parduodamas atskirai.

GARANTIJA TALPAI: 5 metai. GARANTIJA ELEKTRINĖMS DALIMS: 2 metai.

Keraminių kaitinimo elementų komplektai kombinuotiems pastatomiems vandens šildytuvams ATLANTIC

Kodas	Galia	Įtampa	Termostatas	Skirtas modeliui	Kaina, Eur su PVM
009237	2400 W	230/400 V	Kapiliarinis su apsauga nuo perkaitimo	Art. 8840305	153,00
009238	3000 W	230/400 V		Art. 896223	153,00



Vandens šildytuvai ARISTON (Italija)



Markė	Tūris, l	Matmenys (PxGxA), mm	Galia, kW	Sušildymo laikas Δ45°C	ErP	Nuostoliai kWh/parą	Kaina, Eur su PVM	
ANDRIS RS 10/3 EU virš plautuvės	10	360x360x298	1.2	29 min.	A	0.43	149,00	
ANDRIS RS 10U/3 EU po plautuve	10	360x360x298	1.2	29 min.	A	0.55	149,00	
ANDRIS RS 15/3 EU virš plautuvės	15	360x360x324	1.2	44 min.	B	0.53	167,00	
ANDRIS RS 15U/3 EU po plautuve	15	360x360x324	1.2	44 min.	C	0.65	167,00	
ANDRIS RS 30/3 virš plautuvės	30	446x446x410	1.5	1 val.10 min.	B	0.61	176,00	
BLU1 R 50 V EU vertikalus	49	450x550	1.5	1 val. 56 min.	C	0.96	184,00	
BLU1 R 80 V EU vertikalus	75	450x758	1.5	3 val. 6 min	C	1.22	204,00	
BLU1 R 100 V EU vertikalus	95	450x913	1.5	3 val. 52 min.	C	1.39	228,00	
INITIO XP 150 VERT 560 MO EU vertikalus, pakabinamas	150	560x575x1010	1.8	4 val. 50 min.	C	1,48	462,00	
INITIO XP 200 VERT 560 MO EU vertikalus, pakabinamas	200	560x575x1280	2.2	5 val. 17 min.	C	1,73	509,00	
BLU1 R 80 H EU horizontalus	75	793x450	1.5	3 val. 3 min.	C	1.48	234,00	
BLU1 R 100 H EU horizontalus	95	945x450	1.5	3 val. 52 min.	C	1.65	259,00	
ANDRIS ELITE 10/5 (10U/5) virš (po) plautuve, elektr.termostatas	10	360x360x254	1.2	30 min.	A	0.43/0,55	195,00	
ANDRIS ELITE 15/5 (15U/5) virš (po) plautuve, elektr.termostatas	15	360x360x300	1.2	45 min.	A	0.53/0,65	208,00	
ANDRIS ELITE ECO 30/5 virš (po) plautuve, elektr.termostatas	30	446x446x360	1.5	1 val.10 min.	A	0.61	284,00	
BLU1 ECO 50 V EU vertikalus, elektroninis termostatas	49	450x550	1.5	1 val. 56 min.	B	0.96	268,00	
BLU1 ECO 80 V EU vertikalus, elektroninis termostatas	75	450x758	1.5	3 val. 6 min	B	1.22	298,00	
BLU1 ECO 100 V EU vertikalus, elektroninis termostatas	95	450x913	1.5	3 val. 52 min.	B	1.39	317,00	
PRO1 ECO 80 H EU horizontalus, elektr. termostatas	75	758x450	1.8	2 val. 11 min.	B	1.48	339,00	
PRO1 ECO 100 H EU horizontalus, elektr. termostatas	95	913x450	1.8	2 val. 46 min.	B	1.65	362,00	
SHAPE ECO EVO 50 V EU vertikalus, elektroninis termostatas	50	476x489x570	1.8	1 val. 32 min.	B	0.80	293,00	
SHAPE ECO EVO 80 V EU vertikalus, elektroninis termostatas	80	476x489x775	1.8	2 val. 27 min.	B	0.94	315,00	
SHAPE ECO EVO 100 V EU vertikalus, elektroninis termostatas	100	476x489x927	1.8	3 val. 3 min.	B	1.08	357,00	
LYDOS PLUS 50V EU vertikalus, elektroninis termostatas	49	450x550	1.8	1 val. 32 min.	B	0.96	277,00	
LYDOS PLUS 80 V EU vertikalus, elektroninis termostatas	75	450x758	1.8	2 val. 27 min	B	1.22	302,00	
LYDOS PLUS 100 V EU vertikalus, elektroninis termostatas	95	450x913	1.8	3 val. 3 min.	B	1.39	352,00	

Elektriniai vandens šildytuvai ARISTON (Italija)





Markė	Tūris, l	Matmenys, mm	Galia kW	Sušildymo laikas Δ45°C	ErP	Nuostoliai kWh/parą	Kaina, Eur su PVM	
VELIS PRO 50 EU vertikalus/horizontalus, elektroninis termostatas	45	511x275x781	1.5	1 val. 34 min. (46 min.)*	B	1,1	504,00	
VELIS PRO 80 EU vertikalus/horizontalus, elektroninis termostatas	65	511x275x1071	1.5	2 val. 16 min. (46 min.)*	B	1,5	570,00	
VELIS PRO 100 EU vertikalus/horizontalus, elektroninis termostatas	80	511x275x1256	1.5	3 val. 6 min. (46 min.)*	B	1,6	627,00	
VELIS PRO WIFI 50 EU vertikalus/horizontalus, sumanus	45	511x275x781	1.5	1 val. 44 min. (46 min.)*	B	1,1	548,00	
VELIS PRO WIFI 80 EU vertikalus/horizontalus, sumanus	65	511x275x1071	1.5	2 val. 16 min. (46 min.)*	B	1,5	604,00	
VELIS PRO 100 WIFI EU vertikalus/horizontalus, sumanus	80	511x275x1256	1.5	3 val. 6 min. (46 min.)*	B	1,6	633,00	
HPC+ XP 100VERT 560MO R EU vertikalus, titano anodas	100	560x575x770	1.2	4 val. 50 min.	C	1,03	509,00	
HPC+ XP 150VERT 560MO R EU vertikalus, titano anodas	150	560x575x1010	1.8	4 val. 50 min.	C	1,41	565,00	
HPC+ XP 200VERT 560MO R EU vertikalus, titano anodas	200	560x575x1280	2.4	4 val. 50 min.	C	1,73	593,00	
HPC+ XP 250STAB 570MT EU pastatomas, titano anodas, uždaras keraminis elementas	250	570x635x1560	3.0	4 val. 50 min	C	2,09	866,00	
HPC+ XP 300STAB 570MT EU pastatomas, titano anodas, uždaras keraminis elementas	300	570x635x1820	3.0	5 val. 48 min	C	2,45	964,00	

* Sušildymo laikas (dušas paruoštas)

Kombinuoti vandens šildytuvai ARISTON (Italija)



Modelis	Tūris, l	Kaitinimo elemento galia, kW	Šilumokaičio plotas/galia m ² / kW*	Našumas, l/val*	Nuostoliai kWh/parą prie 65°C	Sušildymo laikas Δ45°C, val:min	Matmenys, mm	ErP	Kaina, Eur su PVM	
PRO1 R 80 VTD/VTS EU vertikalus (VTD -dešinės/ VTS – kairės) *	75	1.8	0,15 / 7,5	184	1,51	2:19	450x758	C	245,00	
PRO1 R 100 VTD/VTS EU vertikalus (VTD-ešinės/ VTS – kairės) *	95	1.8	0,15/7,5	184	1,62	2:54	450x913	C	279,00	
BDR-E CDS 100 ARI-EU universalus**	100	1.5	0,7 / 12,3	378	1,08	3:00	505x916	C	665,00	
BDR-E CDS 120 ARI-EU2 universalus**	123	1.5	0,9 / 15,7	498	1,17	3:20	560x1069	C	704,00	
BDR-E CDS 150 ARI-EU2 universalus kombinuotas**	159	1.5	1,2 / 16,37	648	1,87	3:04	560x1279	D	750,00	
BDR-E CDS 200 ARI-EU universalus**	206	2.5	1,7 / 24,16	1112	2,25	4:15	560x1657	E	833,00	

*Prie parametų: 80/15/35°C (šilumnešio temperatūra / įeinančio vandens temperatūra / išeinančio vandens temperatūra),
našumas per šilumokaitį – 0,9 m³/val.

**BDR-E serijos kombinuoti (bakas bake) šildytuvai yra pilnai universalūs. Jos galima montuoti tiek vertikaliai, tiek horizontaliai.
Termofikacinio vandens iš katilo pajungimas iš viršaus ir apačios.

GARANTIJA BAKUI: ANDRIS RS, BLU1 R, PRO1 R, BDR-E serijai – 5 metai; ANDRIS ELITE, LYDOS, BLU1 ECO, PRO1 ECO, SHAPE ECO EVO, HPC+ XP, INITIO ir VELIS – 7 metai.

GARANTIJA ELEKTRINĖMS DALIMS : 2 metai

**ARISTON ženklo vandens šildytuvų garantinį remontą visoje Lietuvoje atlieka UAB „EMTOServis“, Ateities g. 10, Vilnius,
tel. +370 5 2771764, +370 700 44724**

Vandens šildytuvai GORENJE TIKI (Slovėnija)



Markė	Tūris, l	Matmenys PxGxA, mm	Galia, kW	Sušildymo laikas iki 65 °C	Nuostoli ai kWh/parą	ErP	Kaina, EUR
-------	----------	--------------------	-----------	----------------------------	----------------------	-----	------------

Vandens šildytuvai su mechaniniu termostatu, kaitinimo elementai apsaugoti nuo sąlyčio su vandeniu

GB 50 vertikalus/horizontalus	50	500x507x583	2x1000	1val. 55min.	1,00	C	300,00	
GB 80 vertikalus/horizontalus	80	500x507x803	2x1000	3val. 5min.	1,20	C	330,00	
GB 100 vertikalus/horizontalus	100	500x507x948	2x1000	3val.55min.	1,33	C	350,00	
GB 150 vertikalus/horizontalus	150	500x507x1318	2x1000	5val. 45min.	1,64	C	450,00	
GB 200 vertikalus/horizontalus	200	500x507x1510	2x1000	6val. 32min.	2,10	D	600,00	

Vandens šildytuvai su elektroniniu termostatu, kaitinimo elementai apsaugoti nuo sąlyčio su vandeniu

GBU E5 50 vertikalus/horizontalus	50	500x507x590	2x1000	1val. 38min.	1,00	C	370,00	
GBU E5 80 vertikalus/horizontalus	80	500x507x810	2x1000	2val. 37min.	1,20	C	410,00	
GBU E5 100 vertikalus/horizontalus	100	500x507x955	2x1000	3val. 16min.	1,35	C	440,00	
GBU E5 120 vertikalus/horizontalus	120	500x507x1110	2x1000	3val. 55min.	1,55	C	480,00	
GBU E5 150 vertikalus/horizontalus	150	500x507x1325	2x1000	4val. 54min.	1,64	C	540,00	

Kombinuoti vandens šildytuvai su elektroniniu termostatu, kaitinimo elementai apsaugoti nuo sąlyčio su vandeniu

Modelis	Tūris, l	Matmenys PxGxA, mm	Galia, kW	Sušildymo laikas iki 65 °C nuo elektros/nuo katilo	Šilumokaicio plotas/galia, m ² /kW*	Nuostoli ai, kWh/par	ErP	Kaina, Eur su PVM	
GBK 80 E5 RN / LN vertikalus	80	500x507x 810	2x1000	2val.37min./11min.*	0,7/18,75	1,20	C	500,00	
GBK 100 E5 RN / LN vertikalus	100	500x507x 955	2x1000	3val.16min./9min.*	0,9/27,07	1,35	C	540,00	
GBK 120 E5 RN / LN vertikalus	120	500x507x 1110	2x1000	3val.55min./11min.*	0,9/27,07	1,55	C	570,00	
GBK 150 E5 RN / LN vertikalus	150	500x507x 1325	2x1000	4val.54min./14min.*	0,9/27,07	1,64	C	650,00	
GBK 200 E5 RN / LN vertikalus	200	500x507x 1450	2x1000	6val 32min./18min.*	0,9/27,07	2,80	D	750,00	

Izoliacijos storis – 40 mm.

Sušildymo laikas nurodomas vandens temperatūros pakėlimui nuo 15°C iki 65°C.

Sušildymo iki 45°C laikas naudojant šilumokaity – 17-24 min (šilumnešio T-70°C, Q- 50 l/min.)

Šilumokaicio plotas – 0,9 m² (GBK80 – 0,7 m²).

GB modeliai gali būti montuojami dvejopai (vertikalčiai ir horizontalčiai).

GBK modeliams žymėjime LR – pajungimas nuo katilo iš dešinės, LN- pajungimas nuo katilo iš kairės.

GBU, GBK serijos vandens šildytuvams suteikiama 7 metų garantija bakui. Elektrinėms dalims suteikiama 24 mėnesių garantija.

Vandens šildytuvai KOSPEL (Lenkija)



Modelis	Tūris l	Šilumokaičio plotas m ²	Šilumokaičio galia kW	Našumas** l/val	Šilumos nuostoliai W/24val.	Išmatavimai (DxA) mm	ErP	Kaina, Eur su PVM	
---------	---------	------------------------------------	-----------------------	-----------------	-----------------------------	----------------------	-----	-------------------	--

Horizontalūs su šilumokaičiu (gyvatuku) TERMO HIT (maksimalus darbinis slėgis talpa/šilumokaitis – 6,0/6,0 bar)*

WW-80	84	0,30	10	235	56	490x920	C	363,00	
WW-100	107	0,30	10	235	64	490x1125	C	389,00	
WW-120	127	0,40	12	295	66	490x1295	C	446,00	
WW-140	138	0,40	12	295	73	490x1365	C	462,00	

Horizontalūs su šilumokaičiu (bakas bake) TERMO HIT (maksimalus darbinis slėgis talpa/šilumokaitis – 6,0/3,0 bar)

WP-100	109	0,75	20	405	56	510x1080	C	404,00	
WP-120	130	0,95	27	526	65	510x1250	C	438,00	
WP-140	140	1,05	29	567	69	510x1320	C	475,00	

Vertikalūs pastatomi su šilumokaičiu TERMO MAX (maksimalus darbinis slėgis talpa/šilumokaitis 6,0/10,0 bar)

SW-100	105	0,8	24	600	39	500x1200	B	600,00	
SW-120	124	1,0	30	750	43	500x1365	B	664,00	
SW-140	134	1,0	30	750	47	500x1435	B	677,00	
SW-200	204	1,1	32	800	59	590x1610	B	850,00	
SW-250.1	259	1,2	35	875	52	690x1380	B	983,00	
SW-300.1	312	1,5	45	1120	57	690x1615	B	1089,00	
SW-500	465	2,25	65	1620	82	854x1800	C	1727,00	

Vertikalūs pastatomi su dviem šilumokaičiais TERMO SOLAR (maksimalus slėgis talpa/šilumokaitis 6,0/10,0 bar)

SB-200	204	1,1/0,75	32/22	800/550	59	590x1610	B	1009,00	
SB-250.1	257	1,0/0,80	35/24	750/600	54	690x1380	B	1116,00	
SB-300.1	310	1,5/0,80	45/24	1120/600	58	690x1615	B	1195,00	
SB-500	455	2,25/1,04	65/30	1620/750	64	854x1800	C	1939,00	

Vertikalūs pastatomi su pajungimu iš viršaus SWK TERMO TOP (maksimalus darbinis slėgis talpa/šilumokaitis – 6,0/10,0 bar)

SWK-100.A WHITE	97	0,82	25	625	33	595x906	A	638,00	
SWK-120.A WHITE	111	1,0	30	750	36	595x1018	A	677,00	
SWK-140.A WHITE	134	1,1	32	800	38	595x1140	A	757,00	

* Šildytuvai WW ir WP komplektuojami su laikikliu pakabinimui ant sienos.

**Prie parametrų: 80/10/45°C (šilumnešio temperatūra/jeinančio vandens temperatūra/išeinančio vandens temperatūra), našumas per šilumokaitį - 2,5 m³/val.

Garantija bakui 48 mėn. ir 24 mėn. kitoms dalims.

Vandens šildytuvai KOSPEL (Lenkija)



Modelis	Tūris l	Šilumokaičio plotas m ²	Šilumokaičio galia kW	Našumas** l/val	Šilumos nuostoliai W/24val.	Išmatavimai (DxA) mm	ErP	Kaina, Eur su PVM	
---------	---------	------------------------------------	-----------------------	-----------------	-----------------------------	----------------------	-----	-------------------	--

Vertikalūs pastatomi su dideliu šilumokaičiu, tinka šilumos siurbliui (maksimalus darbinis slėgis talpa/šilumokaitis 6,0/10,0 bar)

SWP-200	199	2,1	60	1500	59	595x1610	B	1113,00	
SWP-300	310	2,6	70	1750	59	695x1615	B	1286,00	
SWPC-300	305	4,22	120	1900	61	695x1615	B	1514,00	

Vertikalus pastatomas šilumos siurblio bakas, kur buitinio karšto vandens talpa su šilumokaičiu sujungiama su centrinio šildymo/vėsinimo buferiu viename korpuse (maksimalus darbinis slėgis talpa/šilumokaitis 6,0/3,0 bar)

SWVPC-300	295*	2,7	75	1900	56	695x1610	B	1767,00	
-----------	------	-----	----	------	----	----------	---	---------	---



Vertikalus pastatomas šilumos siurblio šildymo/vėsinimo buferis (maksimalus darbinis slėgis 3,0 bar)

SVK-100.1	101	-	-	-	31	595x906	A	425,00	
-----------	-----	---	---	---	----	---------	---	--------	--

Vertikalus pakabinamas šilumos siurblio šildymo/vėsinimo buferis (maksimalus darbinis slėgis 3,0 bar)

SVH-50	50	-	-	-	30	452x545	B	297,00	
SVH-80	81	-	-	-	42	452x805	B	310,00	
SVH-100	100	-	-	-	46	452x975	B	335,00	

Vert. pastatomos centrinio šildymo buferinės talpos (neemaliuotos, maks. darbinis slėgis talpa/šilumokaitis 3,0/10,0 bar)

SV-200.1	220	-	-	-	53	595x1616	B	531,00	
SV-300.1	324	-	-	-	65	692x1596	B	744,00	
SV-500.1	493	-	-	-	78	854x1761	B	1023,00	
SV-800.1	795	-	-	-	120	994x1900	C	1669,00	
SV-1000.1	942	-	-	-	127	994x2230	C	1964,00	
SVW-200.1	219	0,75	22	550	53	595x1616	B	824,00	
SVW-300.1	322	1,5	45	1120	65	692x1596	B	1009,00	
SVW-500.1	490	2,25	65	1450	78	854x1761	B	1461,00	
SVW-800.1	790	3,0	90	1800	121	994x1900	C	1936,00	
SVW-1000.1	936	3,5	105	2050	128	994x2230	C	2317,00	

* Šildytuvo SWVPC buitinio karšto vandens talpa yra 235 l, centrinio šildymo - 60 l.

**Prie parametrų: 80/10/45°C (šilumnešio temperatūra/jeinančio vandens temperatūra/išeinančio vandens temperatūra), našumas per šilumokaitį - 2,5 m³/val.

Garantija bakui 48 mėn. ir 24 mėn. kitoms dalims.

Vandens šildytuvai KOSPEL (Lenkija)



Modelis	Tūris l	Šilumokaičio plotas m ²	Šilumokaičio galia kW	Našumas** l/val	Šilumos nuostoliai W/24val.	Išmatavimai (DxA) mm	ErP	Kaina, Eur su PVM
---------	---------	------------------------------------	-----------------------	-----------------	-----------------------------	----------------------	-----	-------------------

Akumuliacinė talpa buitiniam karštam vandeniui TERMO (maksimalus darbinis slėgis 6,0 bar)

SE-140	140	-	-	-	47	500x1435	B	478,00
SE-200	210	-	-	-	59	590x1610	B	717,00
SE-250.1	261	-	-	-	51	690x1380	B	770,00
SE-300.1	314	-	-	-	56	690x1615	B	903,00
SE-500	485	-	-	-	83	854x1800	C	1381,00



Garantija bakui 48 mėn. ir 24 mėn. kitoms dalims.

Priedai

GRW-1,4	11/2" Kaitinimo elementas 1,4 KW, 230V su termostatu	74,00
GRW-2	11/2" Kaitinimo elementas 2,0 KW, 230V su termostatu	80,00
GRW-3	11/2" Kaitinimo elementas 3,0 KW su termostatu	100,00
GRW-4,5	11/2" Kaitinimo elementas 4,5 KW, 400V su termostatu	312,00
GRW-6	11/2" Kaitinimo elementas 6,0 KW, 400V su termostatu (nuo 250 litrų)	335,00
AMW400	Magnio anodas 22x420 mm su kamščiu 3/4"	23,00
AMW570	Magnio anodas 31x570 mm su kamščiu 1 1/4"	91,00
AMW660	Magnio anodas 21x660 mm su kamščiu 3/4"	37,00
AMW760	Magnio anodas 31x760 mm su kamščiu 1 1/4"	100,00
AMW800	Magnio anodas 21x840 mm su kamščiu 3/4"	40,00



Elektriniai vandens šildytuvai LUNA (Lenkija)

Modelis	Tūris l	Galios kW	Nominalus slėgis, bar	Sušildymo laikas (Δt=30°C), min	Išmatavimai (P/A/G), mm	ErP	Kaina, Eur su PVM
POC.D5 Luna po plautove	5	2,0	6,0	5,5	285x427x163	A	158,00
POC.G5 Luna virš plautuvės	5	2,0	6,0	5,5	285x427x163	A	158,00
POC.D5-600 Luna po plautove	5	0,6	6,0	18	285x427x163	A	158,00
POC.D10 Luna po plautove	10	2,0	6,0	11	329x470x239	A	217,00
POC.G10 Luna po plautove	10	2,0	6,0	11	329x470x239	A	217,00



Bakas nerūdijančio plieno. Garantija 12 mėn.

Momentiniai vandens šildytuvai KOSPEL (Lenkija)

A



Modelis	Galia, kW	Įtampa, V	Min. laidų skerspjūvis mm ²	Maksimali srovė, A	Įsijungimo momentas, l/min	Našumas, l/min Δ30°C	Kaina, Eur
---------	-----------	-----------	--	--------------------	----------------------------	----------------------	------------

Beslėgiai su maišytuvu (slėgis vandentiekio tinkle – 1,2-6 bar, matmenys PxAxG: 140x211x70 mm)

EPS2-3,5 Twister	3,5	230	3x1,5	15,9	1,1	1,7	96,00
EPS2-4,4 Twister	4,4	230	3x2,5	20	1,7	2,1	99,00
EPS2-5,5 Twister	5,5	230	3x2,5	25	2,0	2,6	103,00



Beslėgiai su dušo komplektu (slėgis vandentiekio tinkle – 1,2-6 bar, matmenys PxAxG: 135x200x69 mm)

EPS2.P-4,4 Prister	4,4	230	3x2,5	20	1,7	2,1	109,00
EPS2.P-5,5 Prister	5,5	230	3x2,5	25	2,0	2,6	112,00



Slėginiai universalaus montavimo (slėgis vandentiekio tinkle – 1,2-6 bar, matmenys PxAxG: 168x200x76 mm)

EPO2-3 Amicus	3,5	230	3x1,5	15,2	1,2	1,7	112,00
EPO2-4 Amicus	4,4	230	3x2,5	19,1	1,6	2,1	112,00
EPO2-5 Amicus	5,5	230	3x2,5	23,9	2,0	2,7	112,00
EPO2-6 Amicus	6,0	230	3x4	26,1	2,0	2,9	112,00



Su elektroniniu valdymu (palaiko nustatytą 52°C temperatūrą, slėgis vandentiekio tinkle 1-10 bar, matmenys PxAxG 250x478x95 mm)

PPE4.L 10/11/12/15	10/11/12 /15	3x400	4x2,5	14,5/15,9/ 17,3/21,7	2,5	4.3/5.2/5.8/ 7.2	308,00
PPE4.L 17/18/21/24	17/18/21 /24	3x400	4x6	24,7/26,0/ 30,3/34,6	2,5	8.1/8.7/10.1 / 11.6	308,00
PPE4.L 27	27	3x400	4x6	39,0	2,5	13,0	308,00



Su elektroniniu valdymu (vandens temperatūros reguliavimas 30-60°C diapazone, slėgis vandentiekio tinkle – 1-10 bar, matmenys PxAxG: 250x478x95 mm su rankenėle, be ekrano)

PPE4.B 10/11/12/15	10/11/12 /15	3x400	4x2,5	14,5/15,9/ 17,3/21,7	2,5	4.3/5.2/5.8/ 7.2	403,00
PPE4.B 17/18/21/24	17/18/21 /24	3x400	4x6	24,7/26,0/ 30,3/34,6	2,5	8.1/8.7/10.1 / 11.6	403,00
PPE4.B 27	27	3x400	4x6	39,0	2,5	13,0	403,00



Su elektroniniu valdymu (LCD ekranas, valdymas su WI-FI per programėlę, slėgis tinkle 1-10 bar, matmenys PxAxG: 250x478x95 mm)

PPE4.M 10/11/12/15	10/11/12 /15	3x400	4x2,5	14,5/15,9/ 17,3/21,7	2,5	4.3/5.2/5.8/ 7.2	460,00
PPE4.M 17/18/21/24	17/18/21 /24	3x400	4x6	24,7/26,0/ 30,3/34,6	2,5	8.1/8.7/10.1 / 11.6	460,00
PPE4.M 27	27	3x400	4x6	39,0	2,5	13,0	460,00



Didelio galingumo su elektroniniu valdymu (slėgis vandentiekio tinkle – 1-6 bar, matmenys PxAxG: 315x492x140 mm)

EPP.1-36 MAXIMUS	36	3x400	4x10	55	2,5	17,3	727,00
------------------	----	-------	------	----	-----	------	--------





GARANTIJA visiems momentiniams šildytuvams: 24 mėnesiai

Magnetiniai nukalkintojai

Modelis	Našumas, l/min	Magnetinė indukcija, gauss	Pajungimas	Kaina, Eur
TAP001UN	10	14000	½"	23,00
TAP001UN	18	14000	¾"	24,00
STOP-CALC34 SMEG	20	18000	¾"	44,00







Atsarginės dalys ARISTON vandens šildytuvams

Kodas	Pavadinimas	Šildytuvo modelis	Kaina, EUR su PVM		
574305	Anodas M4 14X140	SG/PRO/TI SHAPE 10-15/Thermex	5,75		
570241/65104164	Anodas M4 15X210	SG/PRO/TI SHAPE 30	9,60		
65103768	Anodas M5 21,3x110	SG/PRO/ANDRIS/BLU EVO 10-30	8,00		
993014	Anodas M5 25,5x230	SG/TI/PRO R/PRO ECO 50-80-100	13,80		
977127	Anodas M5 25,5x190	TI SHAPE/VELIS 50-80-100	17,00		
993014/1	Anodas M6 25,5x230	SG/TI/PRO/ECO/PLUS 50-100	18,20		
993207-01	Anodas M5-M8 21,3x550	BDR 100-120	17,00		
570285	Anodas M8 21,3x350	NTS, TI 120	24,00		
291088	Anodas M8 21,3x550	BDR 100-120	31,00		
291085	Anodas M8 21,3x660	SG/PRO R/BDR 150	32,00		
291087	Anodas M8 21,3x1000	SG/PRO R/BDR 200	35,00		
60000797	Anodas M8 25,5x440	TI/ARI 200-300 STEA	29,00		
230202/60002768	Apsauginis atbulinis vožtuvas 1"	TI 500	64,00		
60001310	Apsauginis atbulinis vožtuvas 3/4"	BDR 80-100/TI 200-300	22,50		
571730	Apsauginis atbulinis vožtuvas 1/2"	SG/TI TRONIC/PRO/ECO/PLUS	11,70		
60000059	Keraminis elementas 3,0 kW	TI/ARI 200-300 STEATITE	92,00		
65100264	Elementas 1500 W	SG80-100-120HT	29,70		
65150829	Elementas 1,8 kW su flanšu	SHAPE ECO/ECO EVO/PREMIUM 50-80-100V	35,00		
65150048	Elementas 1,5 kW su flanšu	TI SHAPE 50-80-100 H	45,00		
65102465	Elementas 2500 W	SG/TI 200	28,00		
60000689	Elementas 2200 W su tarpinė	ARI 200 THERMO	55,00		
60003458	Elementas 2200 W su tarpinė ir anodu	INITIO XP 200 / ARI 200	49,00		
60002177	Elementas 1,5 kW	BDR-E CDS ARI 80-100-120-150	51,00		
65103321	Elementas 1,5 kW su flanšu	BDR CZ 80-150	78,00		
65103445	Elementas 2,5 kW su flanšu	BDR CZ 200	86,00		
60002181	Elementas 2,5 kW	BDR-E CDS ARI 200	65,00		
65103765	Elementas 1,2 kW su flanšu	SG/PRO/TI SHAPE 10-15-30	26,00		
65103766	Elementas 1,5 kW su flanšu	SG/PRO/TI SHAPE 10-15-30	27,00		
65114905	Elementas 1200 W su tarpinė	ANDRIS RS/BLU EVO 10	38,00		
65114900	Elementas 1200 W su tarpinė	ANDRIS RS/BLU EVO 15	39,00		
65114894	Elementas 1500 W su tarpinė	ANDRIS RS/BLU EVO 30	41,00		
65115173	Elementas 1200 W su tarpinė	ANDRIS LUX ECO 10-15	31,00		
65115175	Elementas 1500 W su tarpinė	ANDRIS LUX ECO 30	39,00		
6501099500	Elementas 1800 W su tarpinė ir anodu	LYDOS PLUS 50-80-100	67,00		
65108913	Elementas 1800 W(iki 2013.02.01)	PRO R/ECO/PLUS 50-80-100	41,00		
65109023	Elementas 1800 W(iki 2013.02.01)	PRO R/ECO/PLUS 50-80-100H	44,00		
65122273	Elementas 1800W(nuo 2013.02.01)	PRO R/BLU R/LYDOS R/PRO R EVO	38,00		
65111874	Elementas 1800W(nuo 2013.02.01)	PRO ECO/PRO R 80-100H	38,00		
6501355200	Elementas 1800W su tarpinė ir anodu	PRO1 ECO/PRO ECO EVO 80-100H	59,00		
65111790	Elementas 1500 W	BLU R/BLU1 R (nuo 2020.01.07)	29,10		
65151226	Elementas 1,0 kW su flanšu	VLS/VLS PLUS 50-80-100	38,00		
65151227	Elementas 1,5 kW su flanšu	VLS/VLS PLUS 50-80-100	39,00		
65115422	Elementas 1,5 kW su tarpinė	BLU1 R V/H	44,00		
65115908	Elementas 1,5 kW su flanšu	VLS EVO/VLS EVO PLUS 50-80-100	58,00		
65115909	Elementas 1,5 kW su flanšu	VLS EVO/VLS EVO PLUS 50-80-100	56,00		
6500581900	Elementas 1,5 kW su flanšu	VLS PRO/VLS PRO WI-FI (tylus)	58,00		
6500582000	Elementas 1,5 kW su flanšu	VLS PRO/VLS PRO WI-FI (tylus)	58,00		
810303	Elementas 2,2 kW su flanšu	SG/TI 150	38,00		
810304	Elementas 2,5 kW su flanšu	SG/TI 200	43,00		

Atsarginės dalys ARISTON vandens šildytuvams

Kodas	Pavadinimas	Šildytuvo modelis	Kaina, EUR su PVM	
814838	Elementas 1200 W	SLE 80	37,00	
816178	Elementas su flanšu 12,0 kW	TI 500 STI	364,00	
816518	Elementas su flanšu 6,0 kW	TI 500 STI	205,00	
816538	Elementas su flanšu 3,0 kW	TI 300STT	214,00	
WTH005UN	Elementas 3,0 kW	Universalus	22,00	
816615	Elementas 1200 W	SG 50-80	18,00	
816616	Elementas 1500 W	SG 100	18,00	
816617	Elementas 1200 W	SG/SIMAT 80H	21,00	
990113	Elementas 2000 W	SG/TI 120	23,00	
992163	Elementas su flanšu 3,0 kW	ARI 300 STAB	138,00	
65109887	Elementas 2000 W	SG 80-100TDX, PRO R 120-150 CZ	26,80	
410660	Apsauga nuo perkaitinimo	EUREKA/TI TECH	9,80	
65150046	Apsauginis termostatas	TI SHAPE 50-80-100	31,00	
212601	Termostatas TR/711-N	BDR	46,00	
411378	Termostatas	SLE 80	57,00	
60003459	Termostatas TBS PLUS	INITIO XP 200/ ARI 200	35,00	
65101080	Termostatas (691499)	SG30/TI SHAPE 30	35,00	
65103771	Termostatas	SG/PRO 10-15-30	31,00	
65114908	Termostatas	ANDRIS RS/BLU EVO 10	22,30	
65115013	Termostatas	ANDRIS RS/BLU EVO 15	28,00	
65114891	Termostatas	ANDRIS RS/BLU EVO 30	31,00	
65117770	Termostatas	BLU1 R 50V (iki 2020.01.07)	27,00	
65119702	Termostatas	BLU1 R 80-100H	28,00	
65119919	Termostatas	BLU1 R 50V (nuo 2020.01.07)	26,00	
65117956	Termostatas	BLU1 R 80V (nuo 2020.01.07)	26,00	
65117957	Termostatas	BLU1 R 100V (nuo 2020.01.07)	25,00	
65115168	Elektroninis termostatas	ANDRIS LUX ECO 10-15-30	53,00	
65152838	Elektroninis termostatas	SHAPE ECO EVO/PREMIUM	45,00	
65108564	Elektroninis termostatas	PRO ECO 50-80-100	56,00	
65108565	Elektroninis termostatas	PRO ECO 50-80-100H	62,00	
65115258	Elektroninis termostatas	PRO PLUS, BLU1 ECO, PRO1 ECO, LYDOS PLUS	51,00	
65115827	Elektroninis termostatas	PRO1 ECO 120-150	50,00	
65152258	Termostato daviklis įleidimo bakui	VLS/VLS PLUS/VLS PREMIUM	18,00	
65151229	Termostato daviklis išleidimo bakui	VLS/VLS PLUS /VLS PREMIUM	16,00	
65153300	Termostato daviklis išleidimo bakui	VLS EVO/VLS Wi-Fi	18,00	
65153301	Termostato daviklis įleidimo bakui	VLS EVO/VLS Wi-Fi	19,00	
65122528	Termostato daviklis įleidimo bakui	VLS PRO/VLS PRO WI-FI	16,00	
65122529	Termostato daviklis išleidimo bakui	VLS PRO/VLS PRO WI-FI	16,00	
691214	Termostatas	SG/PRO R/BDR 80 -100-120	17,00	
691215	Termostatas	SG/PRO R 50-80-100/80H-100H	17,00	
691217	Termostatas su rankenėle	SG/PRO R 50-80-100	17,50	
691219	Termostatas	ARI 200 VERT	59,00	
691556	Termostatas	BDR CZ 80-100-120-150-200	21,00	
691598	Termostatas	SG 30	26,00	
697102	Termostatas	SG/TI 150-200	59,00	
925252	Termostatas	TI 500 STI	199,00	
992162	Termostatas	TI 200/ARI 300 STAB/SPAGNA	79,00	
993189	Termostatas	TI SHAPE QB 50-80-100	25,00	
65115359	Flanšas (4 skyliųčių)	ANDRIS RS/LUX ECO (nuo 2016)	12,00	
65111789	Flanšas (5 skyliųčių)	SG/PRO R/PRO ECO/PRO1/BLU1	16,00	

Atsarginės dalys ARISTON vandens šildytuvams

Kodas	Pavadinimas	Šildytuvo modelis	Kaina, EUR su PVM		
60000686	Flanšas (6 skyliųčių)	ARI/INITIO XP 200	36,00		
570393	Tarpinė flanšui Ø75	BDRM 100-200	3,95		
571312	Tarpinė flanšui Ø75	SG/PRO R/TI 120-200	6,00		
60000687	Tarpinė flanšui Ø105	ARI 200-300	6,40		
65116115	Tarpinė flanšui	ANDRIS/BLU EVO 10-15-30 (nauja)	7,50		
65100282	Tarpinė flanšui	SG/PRO 10-15-30	2,60		
65114660	Tarpinė flanšui	ANDRIS/BLU EVO 10-15-30 (sena)	7,50		
65103691	Flanšas su tarpine	SG/PRO R/TI SHAPE (iki 2013)	13,00		
65111788	Tarpinė flanšui	PRO R,BLU R,PRO ECO (nuo 2013)	4,40		
65150952-FA	Tarpinė flanšui	VLS/VLS EVO (PLUS) 50-80-100	4,90		
65151247	Valdymo plokštė	VLS PREMIUM/VLS PLUS 50-100	110,00		
65116357	Valdymo plokštė	VLS EVO 50 (nuo 2019.01)	74,00		
65116358	Valdymo plokštė	VLS EVO 80 (nuo 2019.01.)	74,00		
65116359	Valdymo plokštė	VLS EVO 100 (nuo 2019.01)	74,00		
65115462	Valdymo plokštė	VLS EVO PLUS 80 (iki 2017)	204,00		
65116367	Valdymo plokštė	VLS EVO PLUS 80 (nuo 2017)	204,00		
65108273	Valdymo plokštė	PRO ECO 50-80-100	21,70		
65117975	Valdymo plokštė	PRO1 ECO 80-100H	42,00		
65117976	Valdymo plokštė	PRO1 ECO 120-150	42,00		
65117978	Valdymo plokštė	BLU1 ECO 50-80-100V	42,00		
65118080	Valdymo plokštė (komplektas)	LYDOS PLUS 50V	75,00		
65118178	Valdymo plokštė (komplektas)	LYDOS PLUS 80-100V	78,00		
65115246	Valdymo plokštė	ANDRIS LUX ECO 10-30 (iki 2017)	42,00		
65116373	Valdymo plokštė	ANDRIS LUX ECO 10-30 (nuo 2017)	42,00		
65120066-01	Valdymo plokštė	VLS Wi-Fi 50	44,00		
65120067-01	Valdymo plokštė	VLS Wi-Fi 80	44,00		
65120068-01	Valdymo plokštė	VLS Wi-Fi 100	44,00		
65122314	Valdymo plokštė	VLS PRO 50	86,00		
65122315	Valdymo plokštė	VLS PRO 80	86,00		
65122316	Valdymo plokštė	VLS PRO 100	86,00		
65122320	Valdymo plokštė	VLS PRO WI-FI 50	140,00		
65122321	Valdymo plokštė	VLS PRO WI-FI 80	140,00		
65122322	Valdymo plokštė	VLS PRO WI-FI 100	140,00		
65153333	Valdymo plokštė	SHAPE ECO EVO 50-80-100V	42,00		
65118495	Wi-Fi modulis	VLS WI-FI 50-80-10	69,00		
65151293	Maitinimo plokštė	VLS/VLS PREMIUM/VLS PLUS	57,00		
65116249	Maitinimo plokštė (65152900)	VLS EVO/VLS EVO PLUS/VLS WI-FI	57,00		
571731	Termometras	SG 50-80-100	9,70		
65108466	Termometras	PRO R 50-80-100	9,70		
65110642	Termometras apvalus	SL/SLE / NTS	12,40		
65117950	Termometras	BLU1 R	10,00		
993010	Lizdas elementui	SG/PRO R 50-80-100	1,90		
993025	Signalinė lemputė	PRO R/TI SHAPE/SLE/BLU1R/PRO1R	6,40		
993186	Signalinė lemputė	SG 50-80-100	6,95		
65108578	Valdymo mygtukai	PRO ECO 50-80-100	9,70		
65117462	Vandens paskirstymo vamzdelis	BLU1, PRO1, LYDOS	6,40		





Atsarginės dalys GORENJE vandens šildytuvams

Kodas	Pavadinimas	Šildytuvo modelis	Kaina, EUR su PVM	
GB	Kaitinimo elementas 1,0kW	GB/GBU/GBK/GBL	20,00	
GBFL	Flanšas	GB/GBU/GBK/GBL	44,00	
GBTARP	Tarpinė flanšui	GB/GBU/GBK/GBL	13,00	
GBAPS	Apsauga nuo perkaitinimo	GB/GBU/GBK/GBL	12,30	
GBTST	Termostatas	GB/GBU/GBK/GBL	29,00	

Atsarginės dalys ATLANTIC vandens šildytuvams

Kodas	Pavadinimas	Šildytuvo modelis	Kaina, EUR su PVM	
040208	Magnio anodas 26x186 M8	VERTIGO STEATITE	23,00	
029041	Apsauginis atbulinis vožtuvas 3/4" 7bar	DUOTHERM, VS200-300	17,90	
029518	Apsauginis atbulinis vožtuvas 3/4" 8bar	DUOTHERM, VS200-300	28,00	
036298	Elementas 2000W	PCSB10-15	23,00	
036429	Elementas 1600W	PCRB10-15	23,00	
030204	Elementas 2000W	NANTO 10-15	20,00	
030205	Elementas 2000W	NANTO 30	22,00	
030222	Elementas 1500W	CLASSIC/OPRO+/EGO	26,00	
036462	Elementas 1500W	HM080-100	27,00	
036530	Elementas 2000W	VM050-100 EXPERT	24,00	
036506	Elementas 1500W	VM050-100 CLASSIC	22,00	
060497	Elementas 2200W, 230V su flanšu, tarpinė ir magnio anodu	DUOTERM 150-200	135,00	
060528	Elementas 1500W su flanšu, tarpinė ir anodu	CWH080-100 MIXED	64,00	
099005	Elementas 2200 W su tarpinė	VM, HM150-200	94,00	
099007	Elementas 300W su flanšu, tarpinė ir anodu	CHAUFFEO 250-300 FS	145,00	
099011	Elementas 3300 W+tarpinė+anodas	VS300	163,00	
030212	Elementas 5000 W	VS500	224,00	
060178	Keraminis elementas 1800 W	ATL150	40,00	
060507	Keraminis elementas 1500 W	ACCESS (CUBE) 30-150	40,00	
060508	Keraminis elementas 2100 W	VM050-100 STEATITE	48,00	
060173	Keraminis elementas 3000 W	CE300	65,00	
029760	Keraminis elementas 2400 W	CUBE WI-FI	58,00	
029591	Keraminis elementas 1000 W	VERTIGO/VERTIGO NEW WI-FI 30-50-80-100 (išleidimo bakui)	46,00	
029618	Keraminis elementas 1000 W	VERTIGO 30 (išleidimo bakui)	45,00	
029592	Keraminis elementas 1500/750 W	VERTIGO 50-80-100 (išleidimo bakui)	51,00	
030249	Keraminis elementas 1500/750 W	VERTIGO NEW WI-FI 50-80-100 (išleidimo bakui)	51,00	
099022	Keraminis elementas 2200 W	ATL200, CE200-300	65,00	
099025	Keraminis elementas 2200 W	ATL200 (881221)	57,00	
026285	Temperatūros sensorius (žalias)	VERTIGO/VERTIGO NEW WI-FI 50	32,00	
026286	Temperatūros sensorius (raudonas)	VERTIGO/VERTIGO NEW WI-FI 80	32,00	
026287	Temperatūros sensorius (mėlynas)	VERTIGO/VERTIGO NEW WI-FI 100	32,00	
026345	Temperatūros sensorius	CUBE WI-FI	26,00	
070195	Termostatas	PC10-15-30SB	14,10	
070196	Termostatas	PC10-15-30RB	14,10	
029532	Termostatas	VM050-100 EXPERT/STEATITE	29,00	



Atsarginės dalys ATLANTIC vandens šildytuvams

Kodas	Pavadinimas	Šildytuvo modelis	Kaina, EUR su PVM		
029577	Termostatas L350	HM150-200 (iki 2015 m.)	42,00		
030349	Termostatas	NANTO 10-15-30	17,00		
070070	Termostatas	HM150-200 (nuo 2015 m.)	14,10		
070130	Termostatas	ATL150	56,00		
070324	Termostatas	INGENIO 50	27,00		
029477	Termostatas	VS300	117,00		
029365	Termostatas GTLH BE 400	CWH 80-100	40,40		
029384	Termostatas BBCS 0143	CE300	60,00		
029580	Termostatas	VS500	110,00		
029619	Termostatas BBCS 0164	CE200	47,00		
029629	Termostatas BSDP0012TC	COMBI 200-300	73,00		
029990	Termostatas TUS00316 VERT L4	STEATITE 150-200 VM	28,70		
030263	Termostatas BSDP0018	STEATITE FS 200/300L 230/400V	91,00		
030452	Termostatas TSX01126 L350E57R62	OPRO+ 100	27,00		
030477	Termostatas GLTX 0030 ECO 58	STEATITE TURBO 50-80-100	24,00		
070126	Termostatas TSE 230V L270	DUOTHERM	44,00		
070273	Termostatas GTLH0407	ACCESS (CUBE) 30-150	37,00		
029659	Apsauginis termostatas SBLC 2001	VERTIGO WI-FI	35,00		
65150046/029531	Apsauginis termostatas	VM050-100 EXPERT/STEATITE	31,00		
029732	Apsauginis termostatas SBLC0059	ACCESS (CUBE WI-FI) 30-150	32,00		
070272	Apsauginis termostatas SBLC0013	VERTIGO 30-50-80-100	43,00		
030350	Apsauginis termostatas KSD315-R	NANTO 10-15-30	12,30		
030773	Apsauginis termostatas SBLC2003	VERTIGO ESSENTIAL 50-100	34,00		
030898	Apsauginis termostatas SBL231001	EXPERT, STEATITE TURBO NEW	22,00		
029584	Valdymo plokštė	VERTIGO 30-50-80-100	134,00		
029661	Valdymo plokštė	VERTIGO ESSENTIAL-50-80-100	48,00		
029863	Valdymo plokštė	VERTIGO WI-FI 50-80-100	196,00		
029968	Valdymo plokštė	CUBE WI-FI/VERTIGO NEW WI-FI	114,00		
029587	Maitinimo plokštė	VERTIGO 30-50-80-100	117,00		
029660	Maitinimo plokštė	VERTIGO ESSENTIAL-50-80-100	117,00		
030552	Maitinimo plokštė	VERTIGO ESSENTIAL NEW 50	79,00		
030553	Maitinimo plokštė	VERTIGO ESSENTIAL NEW 80	79,00		
030554	Maitinimo plokštė	VERTIGO ESSENTIAL NEW 100	79,00		
088689	Maitinimo plokštė su Wi-Fi	VERTIGO WI-FI 50-80-100	100,00		
030250	Maitinimo plokštė su Wi-Fi	VERTIGO NEW WI-FI 30	100,00		
030251	Maitinimo plokštė su Wi-Fi	VERTIGO NEW WI-FI 50 (iki 2025.12)	100,00		
030957	Maitinimo plokštė su Wi-Fi	VERTIGO NEW WI-FI 50 (nuo 2025.12)	100,00		
030252	Maitinimo plokštė su Wi-Fi	VERTIGO NEW WI-FI 80	100,00		
030253	Maitinimo plokštė su Wi-Fi	VERTIGO NEW WI-FI 100	100,00		
030260/030966	Maitinimo plokštė	CUBE WI-FI 75L	100,00/60,00		
030261/030967	Maitinimo plokštė	CUBE WI-FI 100L	100,00/60,00		
030262/030968	Maitinimo plokštė	CUBE WI-FI 150L	100,00/60,00		
040444	Flanšas	PC, EXPERT, CLASSIC, CWH	7,10		
029530	Apsauginis gaubtas elementui	STEATITE TURBO 50-80-100	70,00		
030854	Apsauginis gaubtas elementui	VERTIGO 30 1000W (029589)	52,00		
029620	Apsauginis gaubtas elementui	CE150 1800W	53,00		
040438	Apsauginis gaubtas elementui	ACCESS (CUBE) 30-150 1500W	75,00		

Atsarginės dalys ATLANTIC vandens šildytuvams

Kodas	Pavadinimas	Šildytuvo modelis	Kaina, EUR su PVM	
040439	Apsauginis gaubtas elementui	VERTIGO/CUBE 50-80-100	81,00	
040159	Apsauginis gaubtas elementui	ATL150 STEATITE	95,00	
099035	Apsauginis gaubtas+tarpinė+anodas	CE300	125,00	
040146	Tarpinė elementui	PC10-30,VM050-100,DUOTHERM	0,50	
040323	Tarpinė flanšui	PC10-30, VM050-100, VH080-100	3,00	
099060	Tarpinė flanšui	VM150-200-300	7,60	
040158	Tarpinė flanšui	DUOTHERM	6,00	
029285	Termometras	VM050-100 EXPERT/STEATITE	15,00	
026222	Signalinė lemputė	VM050-100 EXPERT	7,20	
023534	Signalinė lemputė	ATL120 OPRO	7,20	
023534	Termometras	ATL120 OPROP	7,30	
020082	Signalinė lemputė	VM050-100 STEATITE	7,20	
021088	Signalinė lemputė	PC10-15-30	3,10	
023522	Signalinė lemputė	NANTO 10-15-30	5,00	

Kaitinimo elementai su 11/4“ sriegiu

Kodas	Pavadinimas	Šildytuvo modelis	Kaina, EUR su PVM	
WTH120UN	Elementas 1200W (Italija)		14,40	
WTH121UN	Elementas 1500W (Italija)		14,40	
WTH122UN	Elementas 2000W (Italija)		14,40	
WTH125UN	Elementas 3000W (Italija)		19,20	
WTH140UN	Elementas 1200W (Italija)		16,30	
WTH141UN	Elementas 1500W (Italija)		16,30	
WTH142UN	Elementas 2000W (Italija)		16,30	
WTH144UN	Elementas 3000W (Italija)		19,20	
1800	Tarpinė elementui		0,80	
WTH300UN	Anodas M6 16x120		3,50	
WTH306UN	Anodas M6x178 21x110		4,50	

Elektriniai konvektoriai

CEVA CPH-F (ErP Ready)

Konvektoriaus ypatumai:

- mechaninis termostatas;
- nedeginamas kambario deguonis;
- 2-jų pakopų kaitinimo X-formos aliumininis elementas;
- II elektros saugumo klasė, IP24 apsauga, apsauga nuo perkaitimo.

Kodas	Galingumas, W	Plotis, mm	Aukštis, mm	Gylis, mm	Svoris, kg	Kaina, Eur su PVM
CPH-F05	500	440	440	80	4,5	73,00
CPH-F10	1000	520	440	80	4,8	79,00
CPH-F15	1500	680	440	80	5,8	91,00

Komplektacija: konvektorius, elektros laidas su šakute, kojėlės su ratukais ir laikiklis tvirtinimui prie sienos.



CEVA CPH-TX (ErP Ready)

Konvektoriaus ypatumai:

- elektroninis termostatas (5÷50 °C);
- nedeginamas kambario deguonis;
- 3 darbo režimai (ekonominis, komforto, neužšalimo +5÷7 °C);
- laikmatis 24 val.;
- II elektros saugumo klasė, IP24 apsauga, apsauga nuo perkaitimo.

Kodas	Galingumas, W	Plotis, mm	Aukštis, mm	Gylis, mm	Svoris, kg	Kaina, Eur su PVM
CPH-T05X	500	440	440	80	4,0	102,00
CPH-T10X	1000	520	440	80	4,58	113,00
CPH-T15X	1500	680	440	80	5,5	122,00

Komplektacija: konvektorius, elektros laidas su šakute, kojėlės su ratukais ir laikiklis tvirtinimui prie sienos.



Elektriniai konvektoriai



BONJOUR (ErP Ready)

Konvektoriaus ypatumai:

- mechaninis termostatas;
- nedeginamas kambario deguonis;
- II elektros saugumo klasė, IP24 apsauga, apsauga nuo posvyrio ir perkaitimo.

Kodas	Galingumas, W	Plotis, mm	Aukštis, mm	Gylis, mm	Svoris, kg	Kaina, Eur su PVM
649605	500	364	450	78	2,85	81,00
649610	1000	468	450	78	3,2	87,00
649615	1500	606	450	78	4,4	96,00
649620	2000	764	450	78	5,15	104,00
649625	2500	902	450	78	6,3	110,00
517500	Laikikliai sieniniam tvirtinimui					7,00

Komplektacija: konvektorius, elektros laidas su šakute, kojėlės. Papildomai galima įsigyti laikiklius tvirtinimui prie sienos.



F119 DESIGN (ErP Ready)

Konvektoriaus ypatumai:

- elektroninis termostatas;
- nedeginamas kambario deguonis;
- II elektros saugumo klasė, IP24 apsauga, apsauga nuo posvyrio ir perkaitimo;
- elektros energijos taupymas iki 15%;

5 darbo režimai (komfortas, ekonominis, neužšalimas, išjungta, programavimas (valdymas su išoriniu programavimo įrenginiu)).

Kodas	Galingumas, W	Plotis, mm	Aukštis, mm	Gylis, mm	Svoris, kg	Kaina, Eur su PVM
515600	500	391	461	114	3,6	99,00
515601	1000	465	461	114	4,2	106,00
515602	1500	613	461	114	5,2	112,00
515603	2000	761	461	114	6,2	125,00
515604	2500	909	461	114	7,2	134,00
517500	Laikikliai sieniniam tvirtinimui					7,00

Komplektacija: konvektorius, elektros laidas su šakute, kojėlės. Papildomai galima įsigyti laikiklius tvirtinimui prie sienos.



F120 DESIGN (ErP Ready)**Konvektoriaus ypatumai:**

- atviro lango daviklis;
- elektroninis termostatas;
- nedeginamas kambario deguonis;
- II elektros saugumo klasė, IP24 apsauga, apsauga nuo posvyrio ir perkaitimo;
- elektros energijos taupymas iki 25%;
- 3 darbo režimai (ekonominis, komforto, programavimas kiekvienai dienai).

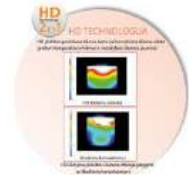

Kodas	Galingumas, W	Plotis, mm	Aukštis, mm	Gylis, mm	Svoris, kg	Kaina, Eur su PVM
002470	500	391	461	114	3,1	131,00
002471	1000	465	461	114	3,7	147,00
002472	1500	613	461	114	4,6	155,00
002473	2000	761	461	114	5,5	173,00
002474	2500	909	461	114	6,2	165,00
517000	Universalios kojelės ir rankena					14,60
517400	Universalios kojelės					12,60



Komplektacija: konvektorius, elektros laidas su šakute, laikikliai sieniniam tvirtinimui. Papildomai galima įsigyti kojeles.



Art. 517300







Art. 517400



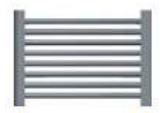

Art. 517500

Elektriniai rankšluosčių džiovintuvai-kopėtėlės ATLANTIC



Markė	Galia, W	Matmenys, mm			Karšto vandens galia, W*	Svoris, kg	Kaina, Eur su PVM	
		Plotis	Aukštis	Gylis				
ATLANTIC 2012 NARROW WHITE								
2012 ETR. 0300W – 831403	300	400	798	100	–	7,0	189,00	 2012 ETR.  2012 DIGIT
2012 DIGIT 0300W – 831411	300	400	889	83	–	16,5	215,00	
2012 DIGIT 0500W – 831412	500	400	1422	83	–	16,5	242,00	
ATLANTIC 2012 CLASSIC WHITE								
2012 DIGIT 0500W – 833620	500	500	1135	83	–	11,6	242,00	
2012 DIGIT 0750W – 833621	750	500	1627	83	–	15,0	261,00	
2012 ETR. 1000W – 831110	1000	550	1781	100	–	22,0	245,00	
2012 DIGIT 1000W – 833622	1000	550	1873	83	–	22,0	294,00	
ATLANTIC 2012 HOT WATER BOILER (kolektorinis pajungimas) maks. slėgis 4 bar								
RSS 2012 EAU CHAUDE 408W RAC.COLL – 831426	–	500	920	100	408	5,6	120,00	 2 skylės 1/2" vandens pajungimui prie kolektorių.
RSS 2012 EAU CHAUDE 609W RAC.COLL – 831619	–	500	1375	100	609	8,3	164,00	
RSS 2012 EAU CHAUDE 844W RAC.COLL – 831849	–	550	1703	100	844	11,2	209,00	
RSS 2012 EAU CHAUDE 942W RAC.COLL – 831950	–	600	1703	100	942	12,7	251,00	
ATLANTIC 2012 HOT WATER CENTRAL (centrinis pajungimas) maks.slėgis 4 bar								
RSS 2012 EAU CHAUDE 408W RAC.CENT – 833426	–	500	920	100	408	5,6	124,00	 2 skylės 1/2" vandens pajungimui (tarpai 50 mm).
RSS 2012 EAU CHAUDE 609W RAC.CENT – 833619	–	500	1375	100	609	8,3	167,00	
RSS 2012 EAU CHAUDE 844W RAC.CENT – 833849	–	550	1703	100	844	11,2	213,00	
RSS 2012 EAU CHAUDE 942W RAC.CENT – 833950	–	600	1703	100	942	12,7	255,00	
DORIS WI-FI								
DORIS DIGITAL 0500W BLC – 850266	500	500	1095	105	–	15,0	270,00	
DORIS DIGITAL 0750W BLC – 850267	750	500	1590	105	–	21,0	333,00	
DORIS DIGITAL 1000W BLC – 850268	1000	550	1828	105	–	30,0	408,00	
DORIS WI-FI FAN su ventiliatoriumi 1000W								
DORIS DIGITAL VENTILO 1500W BLC – 851244	500 + 1000	500	1095	105	–	17,0	312,00	
DORIS DIGITAL VENTILO 1750W BLC – 851245	750 + 1000	500	1590	105	–	23,0	375,00	
DORIS DIGITAL VENTILO 2000W BLC – 851246	1000 + 1000	550	1837	105	–	32,0	440,00	

Elektriniai rankšluosčių džiovintuvai-kopėtėlės ATLANTIC

Markė	Galia W	Matmenys, mm			Karšto vandens galia, W*	Svoris, kg	Kaina, Eur su PVM	
NEFERTITI NARROW (siauras)								
NEFERTITI INITIAL ETR.0500W BLC – 850505	500	450	1450	138	–	17,5	490,00	
NEFERTITI INITIAL ETR.0750W BLC – 850507	750	450	1750	138	–	21,0	618,00	
NEFERTITI (didelis ir pasukamas) su ventiliatoriumi 1000W ir nuotoliniu valdymu								
NEFERTITI INTEGRAL PIV.G 1750W BLC – 850317 (kairės pusės)	750 + 1000	550	1450	150	–	27,0	775,00	
NEFERTITI INTEGRAL PIV.G 2000W BLC – 850320 (kairės pusės)	1000 + 1000	550	1750	150	–	31,0	842,00	
NEFERTITI INTEGRAL PIV.D 2000W BLC – 850420 (dešinės pusės)	1000 + 1000	550	1750	150	–	31,0	842,00	

* - Prie $\Delta t=50^{\circ}\text{C}$ **GARANTIJA: 2 metai.**

Ketinės kieto kuro krosnelės Evergreen (Kinija)

Pavadinimas	Galingumas kW	Dūmtraukio diametras	Išmatavimai, mm Plotis x gylis x aukštis	Kaina, EUR su PVM	
ST 205 SF	5	Ø120 mm	600x310x480 48 kg	318,00	
ST 205 SA	5	Ø120 mm	520x390x500 61 kg	468,00	
ST 0406 GL	7,5	Ø120 mm	432x450x665 70 kg	512,00	
ST 4102 A	8	Ø120 mm	630x430x620 72 kg	546,00	
ST 0408 B	8,5	Ø120 mm	760x410x530 86 kg	592,00	
ST 1021 SB	10	Ø150 mm	790x510x700 127 kg	769,00	
ST 1050 DVY	7	Ø150 mm	655x455x717 135 kg	838,00	
ST 244 A	11,5	Ø150 mm	700x450x780 160 kg	839,00	
ST 244 DS	11,5	Ø150 mm	700x450x780 160 kg	1099,00	
ST 1060 B	4,5	Ø120 mm	820x510x820 160 kg	964,00	
Kapsulė STIN5372-11	15	Ø180 mm	725x510x705 138 kg	550,00	

Elektriniai šildymo katilai KOSPEL (Lenkija)



Modelis	Galia kW	Įtampa, V	Nominali srovė, A	Šildymo plotas**, m ²	Min. maitinimo laidų skersmuo, mm ²	Kaina, Eur su PVM	
---------	----------	-----------	-------------------	----------------------------------	--	-------------------	--

Universalus be išsiplėtimo bakelio, cirkuliacinis siurblys su dažnuminiu valdymu, automatinė galios moduliacija (8 galingumo laipsniai), lauko daviklis komplekte, reguliuojama katilo temperatūra nuo +20 iki +85°C, išmatavimai 418x710x153mm, energijos efektyvumo klasė: D

EKCO.L2M-04	4	230 arba 3x400	18,3 / 6,1	30-50	3x2,5 / 5x1,5	854,00	
EKCO.L2M-06	6	203 arba 3x400	27,4 / 9,1	40-70	3x4 / 5x1,5	854,00	
EKCO.L2M-08	8	230 arba 3x400	36,6 / 12,2	60-100	3x6 / 5x1,5	854,00	
EKCO.L2M-12	12	3x400	18,3	100-140	5x2,5	854,00	
EKCO.L2M-15	15	3x400	22,8	130-180	5x2,5	860,00	
EKCO.L2M-18	18	3x400	27,4	150-220	5x4	860,00	
EKCO.L2M-21	21	3x400	31,9	180-250	5x4	873,00	
EKCO.L2M-24	24	3x400	36,5	220-300	5x6	891,00	
EKCO.L2M-30	30	3x400	45,6	280-320	3x10	1023,00	
EKCO.L2M-36	36	3x400	54,7	340-380	3x10	1086,00	

Universalus su 6 litrų išsiplėtimo bakeliu, cirkuliacinis siurblys su dažnuminiu valdymu, automatinė galios moduliacija (8 galingumo laipsniai), lauko daviklis komplekte, reguliuojama katilo temperatūra nuo +20 iki +85°C, išmatavimai 418x710x197mm, energijos efektyvumo klasė: D

EKCO.LN2M-04	4	230 arba 3x400	18,3 / 6,1	30-50	3x2,5 / 5x1,5	965,00	
EKCO.LN2M-06	6	203 arba 3x400	27,4 / 9,1	40-70	3x4 / 5x1,5	965,00	
EKCO.LN2M-08	8	230 arba 3x400	36,6 / 12,2	60-100	3x6 / 5x1,5	965,00	
EKCO.LN2M-12	12	3x400	18,3	100-140	5x2,5	965,00	
EKCO.LN2M-15	15	3x400	22,8	130-180	5x2,5	971,00	
EKCO.LN2M-18	18	3x400	27,4	150-220	5x4	971,00	
EKCO.LN2M-21	21	3x400	31,9	180-250	5x4	987,00	
EKCO.LN2M-24	24	3x400	36,5	220-300	5x6	1007,00	
EKCO.LN2M-30	30	3x400	45,6	280-420	3x10	1033,00	
EKCO.LN2M-36	36	3x400	54,7	320-500	3x10	1166,00	

Didelio galingumo, skirtas darbui su centriniu šildymo sistema ir buitiniu karšto vandens tūrinio šildytuvu su šilumokaičiu, turi du šildymo blokus, gali dirbti kaskadinėse sistemose, temperatūra reguliuojama nuo +40 iki +85°C, išmatavimai 503x815x197mm, energijos efektyvumo klasė: D

EKCO.T-30	30	3x400	43,3	280 - 320	5X10	2002,00	
EKCO.T-36	36	3x400	52	340 - 380	5X10	2045,00	
EKCO.T-42	42	3x400	60,6	400 - 440	5X10	2089,00	
EKCO.T-48	48	3x400	69,3	440 - 500	5X16	2133,00	
EKCO.TM-30*	30	3x400	43,3	280 - 320	5X10	2294,00	
EKCO.TM-36*	36	3x400	52	340 - 380	5X10	2338,00	
EKCO.TM-42*	42	3x400	60,6	400 - 440	5X10	2382,00	
EKCO.TM-48*	48	3x400	69,3	440 - 500	5X16	2425,00	

- EKCO.T, EKCO.TM modeliai gali dirbti kaskadinėse sistemose (TM – vedantysis, T- vedamasis katilas)
- EKCO.T gali dirbti centriniu šildymo ir karšto vandens šildytuvams
- EKCO.TM modelis su oro temp. kompensacija, gali dirbti su vienu ar dviem centriniu šildymo sistemomis ir karšto vandens šildytuvu.

Pastaba: visų katilų kaitinimo elementai pagaminti iš vario, išskyrus EKCO.R2 modelio kaitinimo elementas pagamintas iš nerūdijančio plieno (nuo 24 kW iš vario).

* Modelis pagal užsakymą.

** Katilo parinkimas atliekamas pagal pastato šilumos balansą.

GARANTIJA: 24 mėnesiai



Elektriniai šildymo katilai KOSPEL (Lenkija)

Modelis	Galia kW	Įtampa, V	Nominali srovė, A	Šildymo plotas**, m ²	Min. maitinimo laidų skersmuo, mm ²	Kaina, Eur su PVM	
---------	----------	-----------	-------------------	----------------------------------	--	-------------------	--

Universalus be išsiplėtimo bakelio, cirkuliacinis siurblys su dažnuminiu valdymu, automatinė galios moduliacija (8 galingumo laipsniai), kambario temperatūros daviklis komplekte, reguliuojama katilo temperatūra nuo +20 iki +85°C, išmatavimai 316x716x191mm, energijos efektyvumo klasė: D

EKCO.L3 4/6/8	4/6/8	3x400	5,8/8,7/11,6	30-100	5x2,5	991,00	
EKCO.L3 12/16/20/24	12/16/20/24	3X400	17,4/23,1//28,8/34,6	100-300	5x2,5/4/4/6	1018,00	

Universalus su 5 litrų išsiplėtimo bakeliu, cirkuliacinis siurblys su dažnuminiu valdymu, automatinė galios moduliacija (8 galingumo laipsniai), kambario temperatūros daviklis komplekte, reguliuojama katilo temperatūra nuo +20 iki +85°C, išmatavimai 316x716x235mm, energijos efektyvumo klasė: D

EKCO.LN3 4/6/8	2/4/6/8	230	8,7/17,4/26,1/34,8	30-100	3x2,5/2,5/4,6	1049,00	
EKCO.LN3 12/16/20/24	12/16/20/24	3X400	17,4/23,1//28,8/34,6	100-300	5x2,5/4/4/6	1076,00	

Universalus be išsiplėtimo bakelio, cirkuliacinis siurblys su dažnuminiu valdymu, automatinė galios moduliacija (8 galingumo laipsniai), lauko ir kambario temperatūros daviklis komplekte, pritaikytas darbui su fotovoltiniu įrenginiu, galimybė nuotoliniu būdu valdyti internetu naudojant specialią programėlę (naudojant papildomą C.MI modulį), gali dirbti kaskadinėse sistemose, reguliuojama katilo temperatūra nuo +23 iki +70°C, išmatavimai 316x716x191mm, energijos efektyvumo klasė: D

EKCO.M3 4/6/8	4/6/8	3x400	5,8/8,7/11,6	30-100	5x2,5	1049,00	
EKCO.M3 12/16/20/24	12/16/20/24	3X400	17,4/23,1//28,8/34,6	100-300	5x2,5/4/4/6	1076,00	

Universalus su 5 litrų išsiplėtimo bakeliu, cirkuliacinis siurblys su dažnuminiu valdymu, automatinė galios moduliacija (8 galingumo laipsniai), lauko ir kambario temperatūros daviklis komplekte, pritaikytas darbui su fotovoltiniu įrenginiu, galimybė nuotoliniu būdu valdyti internetu naudojant specialią programėlę (naudojant papildomą C.MI modulį), gali dirbti kaskadinėse sistemose, reguliuojama katilo temperatūra nuo +23 iki +70°C, išmatavimai 316x716x235mm, energijos efektyvumo klasė: D

EKCO.MN3 4/6/8	2/4/6/8	230	8,7/17,4/26,1/34,8	30-100	3x2,5/2,5/4,6	1108,00	
EKCO.MN3 12/16/20/24	12/16/20/24	3X400	17,4/23,1//28,8/34,6	100-300	5x2,5/4/4/6	1134,00	

Elektriniai šildymo katilai KOSPEL su buitiniu karšto vandens šildytuvu komplekte (Lenkija)





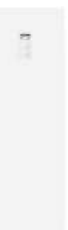



Modelis	Galia kW	Įtampa, V	Nominali srovė, A	Šildymo plotas**, m ²	Vandens šildytuvo sušildymo laikas Δ40°C, min	Min. maitinimo laidų skersmuo, mm ²	Kaina, Eur su PVM	
---------	----------	-----------	-------------------	----------------------------------	---	--	-------------------	--

Universalus dviejų šildymo funkcijų, įmontuotas 130 litrų vandens šildytuvas, du 12 litrų išsiplėtimo bakeliai centrinio šildymo ir vandens šildytuvo šildymo sistemai, cirkuliacinis siurblys su dažnuminiu valdymu, automatinė galios moduliacija (8 galingumo laipsniai), lauko ir kambario temperatūros daviklis komplekte, galimybė nuotoliniu būdu valdyti internetu naudojant specialią programėlę (naudojant papildomą C.MI2 modulį), reguliuojama katilo temperatūra nuo +35 iki +85°C, išmatavimai 580x1745x630mm, energijos efektyvumo klasė: katilas – D, vandens šildytuvas – C

EKD.M3 4/6/8	2/4/6/8	230	8,7/17,4/26,1/34,8	30-100	208/107/72/54	3x2,5/2,5/4,6	3442,00	
EKD.M3 4/6/8	4/6/8	3x400	5,8/8,7/11,6	30-100	208/107/72/54	3x2,5/2,5/2,5		
EKD.M3 12/16/20/24	12/16/20/24	3X400	17,4/23,1//28,8/34,6	100-300	36/29/24/18	5x2,5/4/4/6	3442,00	

GARANTIJA: 24 mėnesiai. Vandens šildytuvo talpai katilo EKD.M3 – 60 mėnesių.

PRIEDA

C.MI	C.MI interneto modulis leidžia nuotoliniu būdu valdyti katilą internetu, naudojant kompiuterį, planšetinį kompiuterį ar išmanųjį telefoną. Valdymas atliekamas per interneto naršyklę, užtikrinantį lengvą ir intuityvų valdymą bei visų pažangių M3 valdiklio funkcijų naudojimą.	243,00	
C.MG3	Modulis C.MG3, prijungtas prie C.MI modulio ir 3 kryptių maišymo vožtuvo su pavara, leidžia valdyti papildomo šildymo kontūro (pvz., grindų šildymo arba centrinio šildymo buferio iškrovimo) veikimą. Sistema gali palaikyti iki 24 šildymo kontūrų (24 C.MG3 moduliai). Komplekte yra temperatūros jutiklis WE 019/01.	151,00	
ZAWÓR.KOT.VC6013	Trijų kryptių vožtuvas AFRISO nr. 16 64200 - AZV 642, G3/4.	83,00	
ZAWÓR.KOT.VC6013	Trijų kryptių vožtuvas HONEYWELL – 3/4" (vožtuvas VCZMH6000E, servo pavara VC6013ZZ00 su kabeliu).	83,00	
CZUJNIK.WE-027	Lauko temperatūros jutiklis EKCO.L2M	15,00	
CZUJNIK.WE-019/01	Temperatūros jutiklis WE-019/01 katilams EKCO.L2, EKCO.LN2, EKCO.M2, EKCO.MN2 (vandens temperatūrai karšto vandens šildytuvo šilumokaityje matuoti).	14,00	
CZUJNIK.WE-008	Temperatūros jutiklis WE-008 katilams EKCO.T ir EKCO.TM (vandens temperatūrai karšto vandens šildytuvo šilumokaityje matuoti).	15,40	
AURATON.Tucana	Kambario temperatūros reguliatorius AURATON TUCANA.	27,50	













Išsiplėtimo indai šildymo sistemoms VAREM (Italija)

Diafragminiai išsiplėtimo indai centrinio šildymo sistemoms, atitinka ES direktyvą 97/23/CE. Sintetinė gumos membrana atitinka DIN 4807-3, netinka geriamo vandens sistemoms.

Darbinė temperatūra: (-10^o C - +99^o C). Oro slėgis -1,5 bar. **Garantija – 12 mėn.**

Pavadinimas	Talpa, l	Maks. slėgis bar	Pajungimas	Išmatavimai Ø x L, mm	Kaina, Eur su PVM	
LR 8	8	6	3/4"	200x330	30,00	
LR 12	12	6	3/4"	270x310	38,00	
LR 18	18	6	3/4"	270x425	41,00	
LR 25	25	6	3/4"	290x468	49,00	
LR V 35	35	5	3/4"	320x525	77,00	
LR 40	40	5	3/4"	320x580	80,00	
LR V 50	50	6	3/4"	380x620	94,00	
LR V 60	60	6	1"	380x670	107,00	
LR V 80	80	6	1"	450x662	139,00	
LR V 100	100	6	1"	450x730	193,00	
LR V 150	150	6	1 1/2"	554x807	267,00	
LR V 200	200	6	1 1/2"	554x988	331,00	
LR V 300	300	6	1 1/2"	630x1160	473,00	
LR V 500	500	6	1 1/2"	775x1250	945,00	

Žalvarinės jungtys PE vamzdžiams (Italija)

Serija	Kodas	Pavadinimas	Kaina, €		Serija	Kodas	Pavadinimas	Kaina, €			
3000	0400	Jungtis 20x1/2" M	5,50		3037	0443	Alkūnė 25x3/4" F	9,10			
	0412	Jungtis 25x1/2" M	10,90			0444	Alkūnė 32x1" F	16,50			
	0402	Jungtis 25x3/4" M	9,60			0471	Alkūnė 40x11/4" F	28,10			
	0401	Jungtis 25x1" M	12,70			0472	Alkūnė 50x11/2" F	35,20			
	0429	Jungtis 32x3/4" M	16,00			0473	Alkūnė 63x2" F	62,70			
	0403	Jungtis 32x1" M	12,70			3039	0426	Alkūnė 20		11,20	
	0439	Jungtis 32x11/4" M	18,60				0428	Alkūnė 25		13,20	
	0405	Jungtis 40x11/4" M	21,60				0431	Alkūnė 32		18,60	
	0407	Jungtis 50x11/2" M	26,40				0432	Alkūnė 40		36,50	
	0408	Jungtis 50x2" M	34,70				0433	Alkūnė 50		51,70	
0462	Jungtis 63x2" M	42,90	0479	Alkūnė 63	76,50						
3005	0430	Jungtis 25x3/4" F	9,40		3007	0442	Jungtis 25x1" su veržle	10,40			
	0409	Jungtis 25x1" F	13,90			0441	Jungtis 32x1" su veržle	13,10			
	0410	Jungtis 32x1" F	12,00			0463	Jungtis 32x11/4" su veržle	16,20			
	0456	Jungtis 40x11/4" F	18,20			0464	Jungtis 40x11/2" su veržle	26,50			
	0455	Jungtis 50x11/2" F	26,40			0465	Jungtis 50x11/2" su veržle	38,90			
	0440	Jungtis 50x2" F	33,60			0466	Jungtis 50x2" su veržle	41,40			
	0461	Jungtis 63x2" F	42,90			3036	0446	Alkūnė 25x1" su veržle		14,00	
3015	0436	Mova 20	11,20	0447	Alkūnė 32x1" su veržle		18,00				
	0411	Mova 25	11,60	0467	Alkūnė 32x11/4" su veržle		23,40				
	0413	Mova 32	15,30	0468	Alkūnė 40x11/2" su veržle		36,90				
	0414	Mova 40	30,30	0469	Alkūnė 50x11/2" su veržle		49,90				
	0434	Mova 50	39,80	0470	Alkūnė 50x2" su veržle		52,40				
0480	Mova 63	71,50	0483	0483	Įdėklas vamzdžiui DN32	2,30					
3020	0427	Trišakis 20x1/2"M		9,70	0484	Įdėklas vamzdžiui DN40		4,10			
	0415	Trišakis 25x3/4"M		14,10	0485	Įdėklas vamzdžiui DN50		4,60			
	0416	Trišakis 32x1"M	22,70								
	0437	Trišakis 40x11/4"M	34,10								
	0438	Trišakis 50x11/2"M	49,90								
3025	0457	Trišakis 25x3/4" F	13,90								
	0474	Trišakis 32x1" F	19,60								
	0475	Trišakis 40x11/4" F	38,50								
	0476	Trišakis 50x11/2" F	60,50								
	0477	Trišakis 63x2" F	82,50								
3030	0417	Trišakis 20	13,80								
	0418	Trišakis 25	18,60								
	0419	Trišakis 32	26,00								
	0420	Trišakis 40	45,80								
	0421	Trišakis 50	75,40								
	0481	Trišakis 63	107,00								
3035	0452	Alkūnė 20x1/2" M	7,70								
	0422	Alkūnė 25x3/4" M	9,00								
	0423	Alkūnė 32x1" M	16,50								
	0424	Alkūnė 40x11/4" M	26,40								
	0425	Alkūnė 50x11/2" M	38,00								
	0482	Alkūnė 63x2" M	58,30								

M - Išorinis sriegis

F - Vidinis sriegis

Plastikinės jungtys PE vamzdžiams

Kodas	Pavadinimas	Kaina, €
Jungtys su išoriniu sriegiu 		
D510C	Jungtis 20x1/2" M	1,70
D510D	Jungtis 20x3/4" M	2,00
D510B	Jungtis 25x1/2" M	2,20
D510E	Jungtis 25x3/4" M	2,20
D510F	Jungtis 25x1" M	2,50
D510G	Jungtis 32x3/4" M	3,20
D510H	Jungtis 32x1" M	3,20
D510K	Jungtis 40x1" M	5,00
D510L	Jungtis 40x1 1/4" M	4,30
D510M	Jungtis 40x1 1/2" M	5,50
D510O	Jungtis 50x1 1/2" M	7,50
D510P	Jungtis 50x2" M	7,50
D510R	Jungtis 63x2" M	10,00
D510S	Jungtis 63x2 1/2" M	11,00
Jungtys su vidiniu sriegiu 		
D512D	Jungtis 20x3/4" F	1,60
D512B	Jungtis 25x1/2" F	2,00
D512F	Jungtis 25x3/4" F	2,20
D512G	Jungtis 25x1" F	2,80
D512J	Jungtis 32x3/4" F	3,30
D512H	Jungtis 32x1" F	3,50
D512P	Jungtis 32x1 1/4" F	4,60
D512L	Jungtis 40x1 1/4" F	3,50
D512S	Jungtis 40x1 1/2" F	5,70
D512M	Jungtis 50x1 1/2" F	6,50
D512R	Jungtis 50x2" F	7,50
Movos 		
D514B	Mova 20	3,30
D514C	Mova 25	4,20
D514D	Mova 32	5,50
D514E	Mova 40	8,90
D514F	Mova 50	12,00
D514G	Mova 63	17,50
Perėjimai 		
D516B	Perėjimas 25x20	3,90
D516C	Perėjimas 32x25	5,30
D516D	Perėjimas 40x32	6,50
D516E	Perėjimas 32x20	4,60
D516G	Perėjimas 50x40	7,70
Trišakiai 		
D518B	Trišakis 20	4,50
D518C	Trišakis 25	4,20
D518D	Trišakis 32	7,80
D518E	Trišakis 40	12,90
D518F	Trišakis 50	18,50
Aklės 		
D515B	Aklė 25	2,80
D515C	Aklė 32	3,30
D515D	Aklė 40	5,30
D515E	Aklė 50	5,00

Kodas	Pavadinimas	Kaina, €
Trišakiai su vidiniu sriegiu 		
D520C	Trišakis 25x1/2"x25 F	2,90
D520D	Trišakis 25x3/4"x25 F	3,00
D520E	Trišakis 25x1"x25 F	3,15
D520A	Trišakis 32x1/2"x32 F	3,00
D520H	Trišakis 32x1"x32 F	3,90
Trišakiai su išoriniu sriegiu 		
D521B	Trišakis 25x1/2"x25 M	2,40
D521C	Trišakis 25x3/4"x25 M	2,50
D521H	Trišakis 32x3/4"x32 M	4,00
D521D	Trišakis 32x1"x32 M	5,30
D521E	Trišakis 40x1 1/4"x40 M	12,00
D521F	Trišakis 50x1 1/2"x50 M	13,50
Redukciniai trišakiai 		
D522A	Trišakis 25x20x25	4,20
D522B	Trišakis 32x25x32	8,30
D522C	Trišakis 40x32x40	7,50
D522D	Trišakis 50x40x50	16,00
Alkūnės 		
D524B	Alkūnė 20	3,40
D524C	Alkūnė 25	4,60
D524D	Alkūnė 32	5,80
D524E	Alkūnė 40	9,70
D524F	Alkūnė 50	13,80
D524G	Alkūnė 63	19,00
Alkūnės su išoriniu sriegiu 		
D525G	Alkūnė 20x1/2" M	1,60
D525A	Alkūnė 25x1/2" M	2,40
D525B	Alkūnė 25x3/4" M	3,00
D525H	Alkūnė 25x1" M	3,20
D525C	Alkūnė 32x3/4" M	3,70
D525D	Alkūnė 32x1" M	3,90
D525E	Alkūnė 40x1 1/4" M	7,70
Alkūnės su vidiniu sriegiu 		
D526C	Alkūnė 20x1/2" F	1,60
D526D	Alkūnė 20x3/4" F	1,70
D526E	Alkūnė 25x1/2" F	2,20
D526F	Alkūnė 25x3/4" F	2,20
D526M	Alkūnė 25x1" F	2,30
D526H	Alkūnė 32x3/4" F	3,60
D526I	Alkūnė 32x1" F	4,30
D526K	Alkūnė 40x1" F	7,70
D526O	Alkūnė 50x2" F	10,60
Alkūnė su tvirtinimu 		
D525TV20	Alkūnė 20x1/2" F	3,50
D525TV	Alkūnė 25x3/4" F	6,70
M – Išorinis sriegis, F – vidinis sriegis		









Žalvariniai srieginiai sujungimai



Kodas	Pavadinimas	Kaina, €		
TR0012	Trišakis 1/2"	3,90		
TR0034	Trišakis 3/4"	5,40		
TR0100	Trišakis 1"	9,90		
TR0114	Trišakis 1 1/4"	25,30		
TR0112	Trišakis 1 1/2"	33,00		
TR0200	Trišakis 2"	43,00		
TR1234	Trišakis 3/4x1/2x3/4"	6,20		
TR3401	Trišakis 1x3/4x1"	10,10		
TR1201	Trišakis 1x1/2x1"	12,00		
TR1114	Trišakis 1 1/4x1x1 1/4"	23,10		
KE0012	Keturšakis 1/2"	7,50		
KE0034	Keturšakis 3/4"	11,90		
KE0100	Keturšakis 1"	23,70		
KE0114	Keturšakis 1 1/4"	30,30		
KE0112	Keturšakis 1 1/2"	42,90		
KE0200	Keturšakis 2"	48,40		
AL0012	Alkūnė 1/2" V/V	2,90		
AL0034	Alkūnė 3/4" V/V	5,10		
AL0100	Alkūnė 1" V/V	8,70		
AL0114	Alkūnė 1 1/4" V/V	16,20		
AL0112	Alkūnė 1 1/2" V/V	27,00		
AL0200	Alkūnė 2" V/V	35,80		
ALP0014	Alkūnė 1/4" V/I	4,00		
ALP0012	Alkūnė 1/2" V/I	3,90		
ALP0034	Alkūnė 3/4" V/I	5,80		
ALP0100	Alkūnė 1" V/I	9,00		
ALP0114	Alkūnė 1 1/4" V/I	17,30		
ALP0112	Alkūnė 1 1/2" V/I	25,00		
ALP0200	Alkūnė 2" V/I	46,20		
NI0014	Nipelis 1/4"	1,30		
NI0038	Nipelis 3/8"	2,10		
NI0012	Nipelis 1/2"	1,60		
NI0034	Nipelis 3/4"	2,30		
NI0100	Nipelis 1"	4,00		
NI0114	Nipelis 1 1/4"	8,30		
NI0112	Nipelis 1 1/2"	11,00		
NI0200	Nipelis 2"	19,80		
NR1412	Nipelis red. 1/4"x1/2"	1,80		
NR3812	Nipelis red. 3/8"x1/2"	2,00		
NR1234	Nipelis red. 1/2"x3/4"	2,20		
NR1201	Nipelis red. 1/2"x1"	3,80		
NR3401	Nipelis red. 3/4"x1"	3,90		
NR34114	Nipelis red. 3/4"x1 1/4"	7,60		
NR34112	Nipelis red. 3/4"x1 1/2"	10,10		
NR1114	Nipelis red. 1"x1 1/4"	6,50		
NR1112	Nipelis red. 1"x1 1/2"	11,00		
NR114112	Nipelis red. 1 1/4"x1 1/2"	11,50		
NR11402	Nipelis red. 1 1/4"x2"	17,40		
NR11202	Nipelis red. 1 1/2"x2"	19,30		
NR2212	Nipelis red. 2"x2 1/2"	48,00		
JM1512	Jungtis met.v. 15x1/2"	10,30		
JM2034	Jungtis met.v. 20x3/4"	12,10		
JM2501	Jungtis met.v. 25x1"	24,30		

Kodas	Pavadinimas	Kaina, €	
MO0014	Mova 1/4"	1,90	
MO0012	Mova 1/2"	2,90	
MO0034	Mova 3/4"	3,60	
MO0100	Mova 1"	5,80	
MO0114	Mova 1 1/4"	7,20	
MO0112	Mova 1 1/2"	12,60	
MO0200	Mova 2"	24,20	
MR1234	Mova redukuota 1/2"x3/4"	3,70	
MR3401	Mova redukuota 3/4"x1"	5,10	
MR1114	Mova redukuota 1"x1 1/4"	9,90	
MR114112	Mova redukc. 1 1/4"x1 1/2"	13,20	
MR11402	Mova redukuota 1 1/4"x2"	22,60	
MR11202	Mova redukuota 1 1/2"x2"	20,90	
AV0012	Aklė 1/2" V	1,30	
AV0034	Aklė 3/4" V	2,10	
AV0100	Aklė 1" V	3,20	
AI0012	Aklė 1/2" I	1,80	
AI0034	Aklė 3/4" I	1,90	
AI0100	Aklė 1" I	3,00	
RT1438	Redukcija 1/4"x3/8" V/I su t.	2,10	
RT3812	Redukcija 3/8"x1/2" V/I su t.	3,50	
RT1234	Redukcija 1/2"x3/4" V/I su t.	4,80	
RT3401	Redukcija 3/4"x1" V/I su t.	6,90	
R1438	Redukcija 3/8"x1/4" V/I	1,80	
R1234	Redukcija 3/4"x1/2" V/I	4,00	
R3401	Redukcija 1"x3/4" V/I	5,20	
R1114	Redukcija 1 1/4"x1" V/I	6,00	
IV1412	Įvorė redukc. 1/4"x1/2" V/I	1,30	
IV1234	Įvorė redukc. 1/2"x3/4" V/I	1,60	
IV1201	Įvorė redukc. 1/2"x1" V/I	3,60	
IV3401	Įvorė redukc. 3/4"x1" V/I	3,00	
IV34114	Įvorė redukc. 3/4"x1 1/4" V/I	8,40	
IV1114	Įvorė redukc. 1"x1 1/4" V/I	5,30	
IV1112	Įvorė redukc. 1"x1 1/2" V/I	10,50	
IV114112	Įvorė redukc. 1 1/4"x1 1/2"	7,30	
IV11402	Įvorė redukc. 1 1/4"x2" V/I	17,60	
IV11202	Įvorė redukc. 1 1/2"x2" V/I	17,10	
KO0012	Kontraveržlė 1/2"	0,90	
KO0034	Kontraveržlė 3/4"	2,00	
KO0100	Kontraveržlė 1"	2,90	
AM0012	Išardoma jungtis tiesi 1/2"	5,90	
AM0034	Išardoma jungtis tiesi 3/4"	7,40	
AM0100	Išardoma jungtis tiesi 1"	12,00	
AM0114	Išardoma jungtis tiesi 1 1/4"	22,00	
AM0112	Išardoma jungtis tiesi 1 1/2"	37,40	
AM0200	Išardoma jungtis tiesi 2"	58,30	
AMK0012	Išardoma jungtis kamp. 1/2"	6,50	
AMK0034	Išardoma jungtis kamp. 3/4"	10,50	
AMK0100	Išardoma jungtis kamp. 1"	16,80	
AMK0114	Išardoma jungtis kamp. 1 1/4"	30,80	
IL0100	Ilgasriegis 1"x100	11,60	
IL0120	Ilgasriegis 1"x200	23,10	
IL0130	Ilgasriegis 1"x300	35,80	

Rutuliniai ventiliai TIEMME, atbuliniai vožtuvai, purvarinkiai

Kodas	Matmuo	Kaina, € su PVM	
Ventilis rutulinis TIEMME su ilga rankena vidus/vidus, PN30, $t_{max}=150^{\circ}C$,			
V0012E	1/2	6,00	
V0034E	3/4	9,80	
V0100E	1	14,10	
V0114E	1 1/4	31,00	
V0112E	1 1/2	39,00	
V0200E	2	70,00	
Ventilis rutulinis TIEMME su ilga rankena Išorė/vidus, PN30, $t_{max}=150^{\circ}C$			
VP0012E	1/2	6,90	
VP0034E	3/4	10,70	
VP0100E	1	15,90	
VP0114E	1 1/4	31,00	
VP0112E	1 1/2	47,00	
VP0200E	2	72,00	
Ventilis rutulinis TIEMME su trumpa rankena vidus/vidus, PN30, $t_{max}=150^{\circ}C$			
VT0012E	1/2	6,40	
VT0034E	3/4	9,10	
VT0100E	1	14,70	
Ventilis rutulinis TIEMME su trumpa rankena Išorė/vidus, PN30, $t_{max}=150^{\circ}C$			
VTP0012E	1/2	7,20	
VTP0034E	3/4	10,80	
VTP0100E	1	16,50	
Ventilis rutulinis su ardому sujungimu ir trumpa rankena, PN30, $t_{max}=90^{\circ}C$			
VAM0012	1/2	10,50	
VAM0034	3/4	15,30	
VAM0100	1	21,80	
Ventilis kampinis TIEMME su ardому sujungimu kolektoriams, PN30, $t_{max}=150^{\circ}C$			
VTPK0012	1/2	14,30	
VTPK0034	3/4	21,50	
VTPK0100	1	27,50	
Sodo ventilis, PN10, $t_{max}=90^{\circ}C$			
VS12	1/2	10,50	
VS34	3/4	14,90	
VS10	1	21,30	
Purvarinkis filtras, PN20, $t_{max}=120^{\circ}C$			
PF05	1/2	4,50	
PF075	3/4	9,00	
PF1	1	12,10	
PF125	1 1/4	17,60	
PF15	1 1/2	27,00	
PF2	2	43,00	
Atbulinis vožtuvas horizontalus, PN10, $t_{max}=100^{\circ}C$			
VH05	1/2	8,60	
VH075	3/4	9,40	
VH1	1	13,20	
VH125	1 1/4	20,40	
VH15	1 1/2	26,60	
VH2	2	36,00	

PVC TECHNINĖS ŽARNOS ESPIROFLEX (Ispanija)

PVC spirale armuotos žarnos siurbliams TRANSLIQUID AMARILLO „S“

Darbinė temperatūra nuo -15°C iki $+60^{\circ}\text{C}$

Vidinis diam, mm	20	25	32	40	50
Metrų rulone	50	50	50	50	50
Darbo slėgis, bar	7	7	7	6	6
Vakuumo slėgis, bar	6	6	6	6	6
Kaina, Eur/m su PVM	2,85	3,69	4,19	6,05	8,60

ESPIROCRISTAL (PVC skaidri žarna)

Darbinė temperatūra nuo -10°C iki $+60^{\circ}\text{C}$

Diametras, mm	4x6	6x9	8x12	10x14	12x16	16x22	19x27	25x31
Metrų rulone	100	50/100	50/100	50/100	50	50	50	50
Kaina, EUR/m su PVM	0,29	0,60	0,93	1,15	1,85	2,53	3,75	4,20

MALLATRANS (PVC žarna armuota poliesterio tinkleliu)

Darbinė temperatūra nuo -10°C iki $+60^{\circ}\text{C}$

Diam. mm	6x12	8x14	10x16	13x19	16x22	19x25	25x33	32x42	40x52	50x62
Metrų rulone	50	50	50	50	50	50	50	50	50	50
Maks slėgis, bar	16	15	14	11	10	9	8	8	7	6
Kaina, EUR/m	1,05	1,77	2,04	2,95	3,20	3,50	5,60	8,80	9,45	12,20

WATERFLAT L PVC plokščia žarna (armuota poliesterio siūlais)

Darbinė temperatūra nuo -10°C iki $+60^{\circ}\text{C}$

Diametras, mm	35	40	50
Metrų rulone	50	50	50
Darbo slėgis, bar	5	5	5
Kaina EUR/m su PVM	3,20	3,70	5,20

ŽARNA SUSPAUSTAM ORUI - ESPIROPRES

Darbinė temperatūra nuo -10°C iki $+60^{\circ}\text{C}$

Diametras, mm	6x12	10x17	19x30
Metrų rulone	100	100	50
Darbo slėgis, bar	10	10	10
Kaina, EUR/m su PVM	0,87	1,15	2,95